

B9

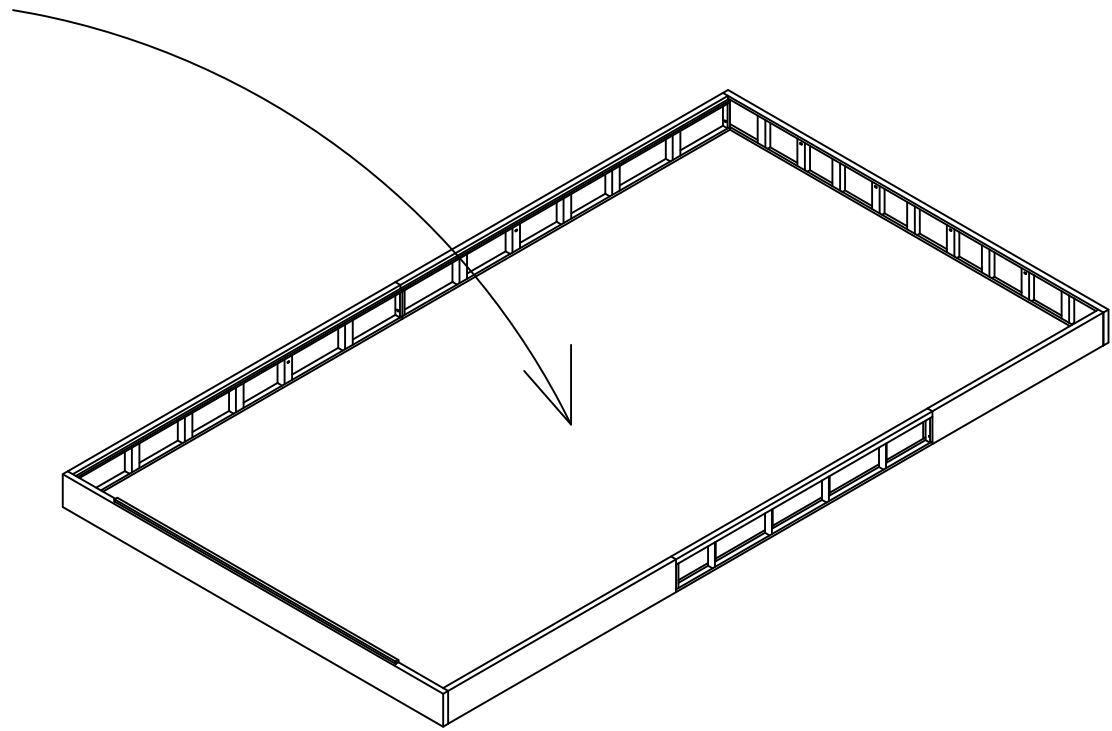

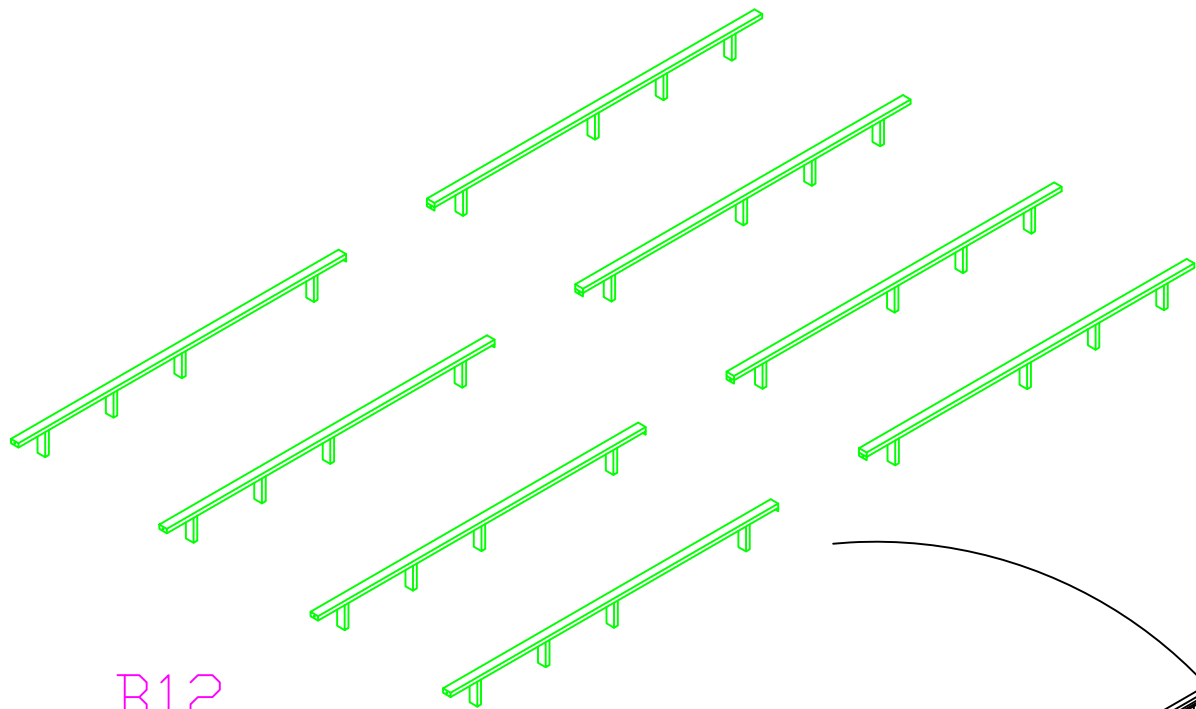

B12

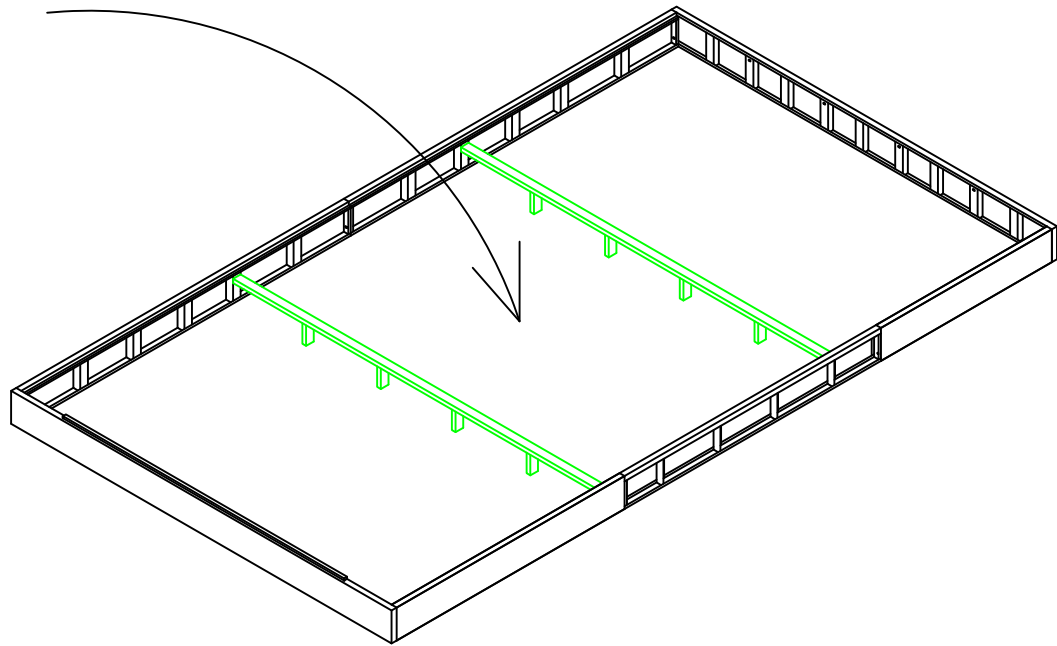

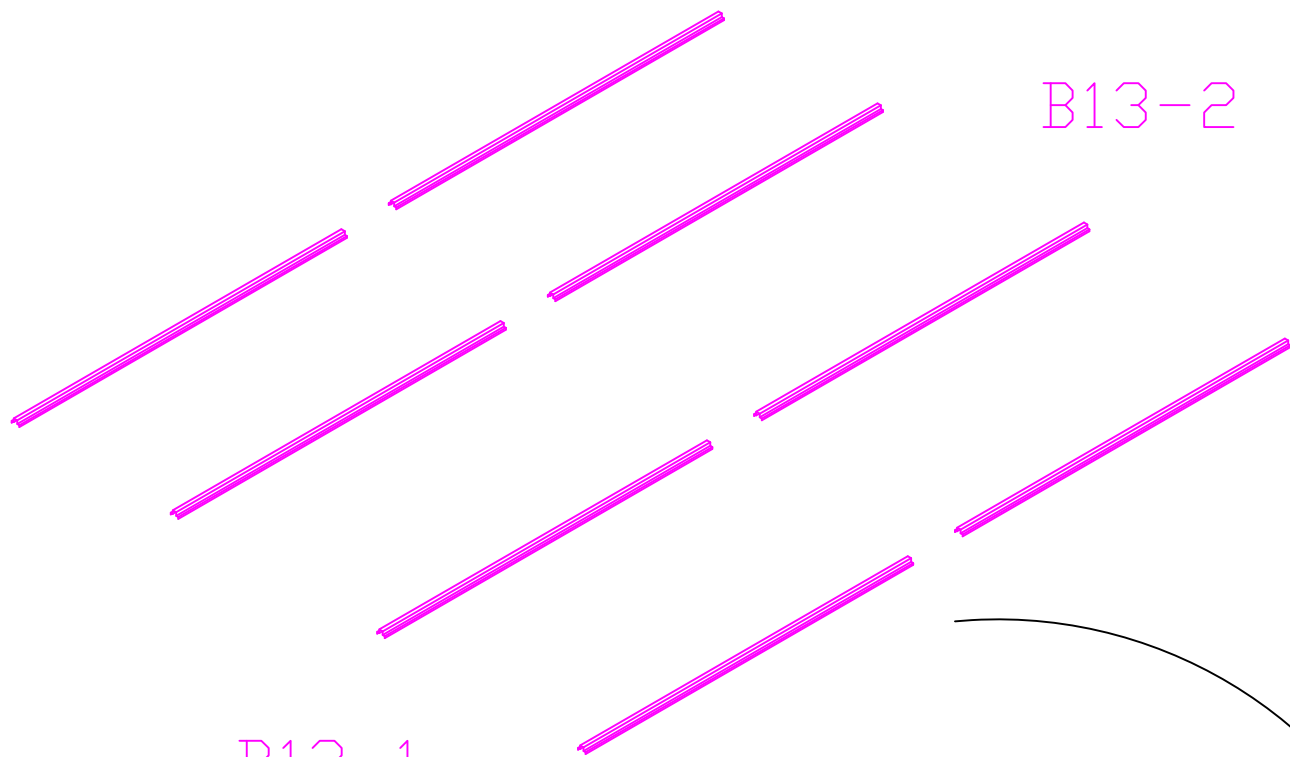

B13-1

B13-2

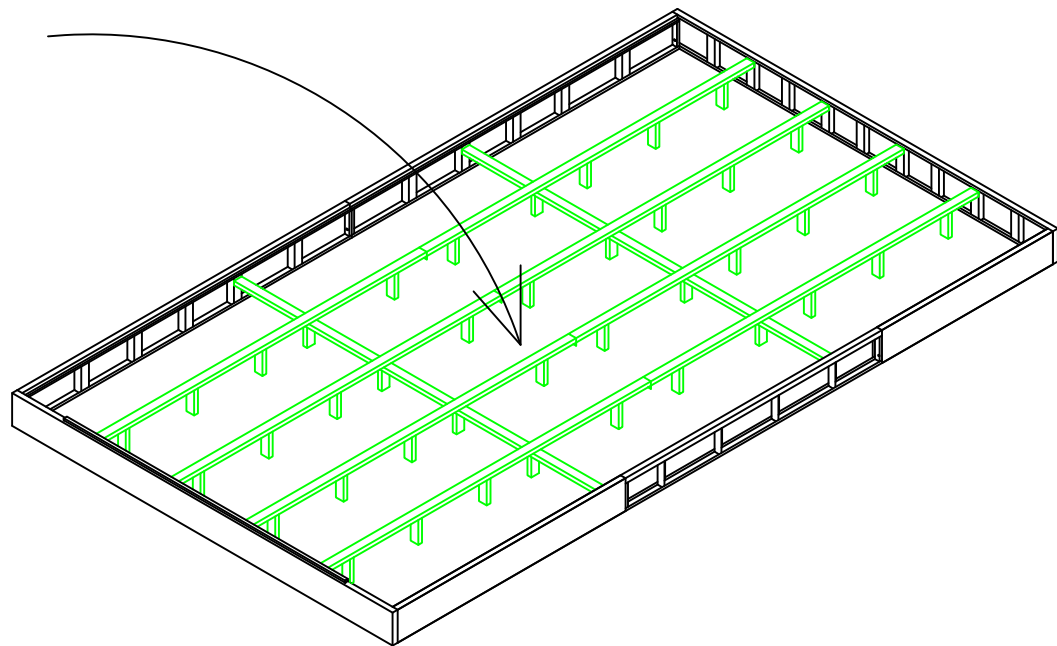

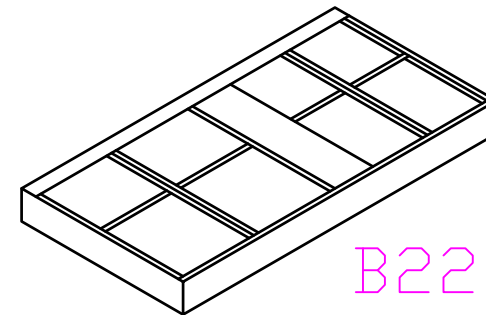
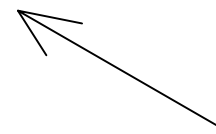
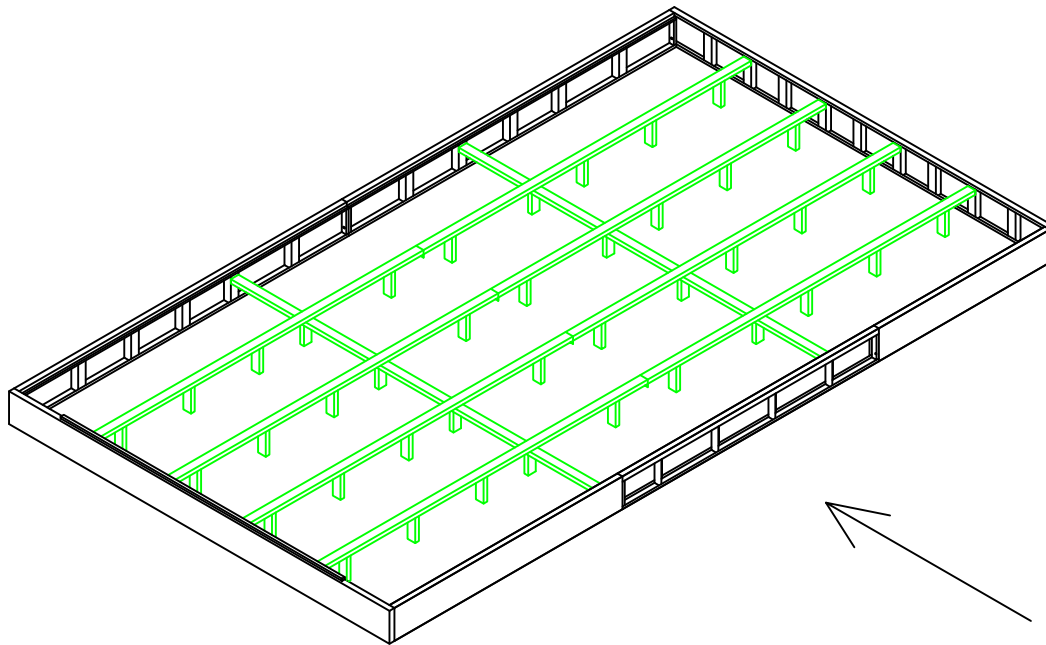

B22

005

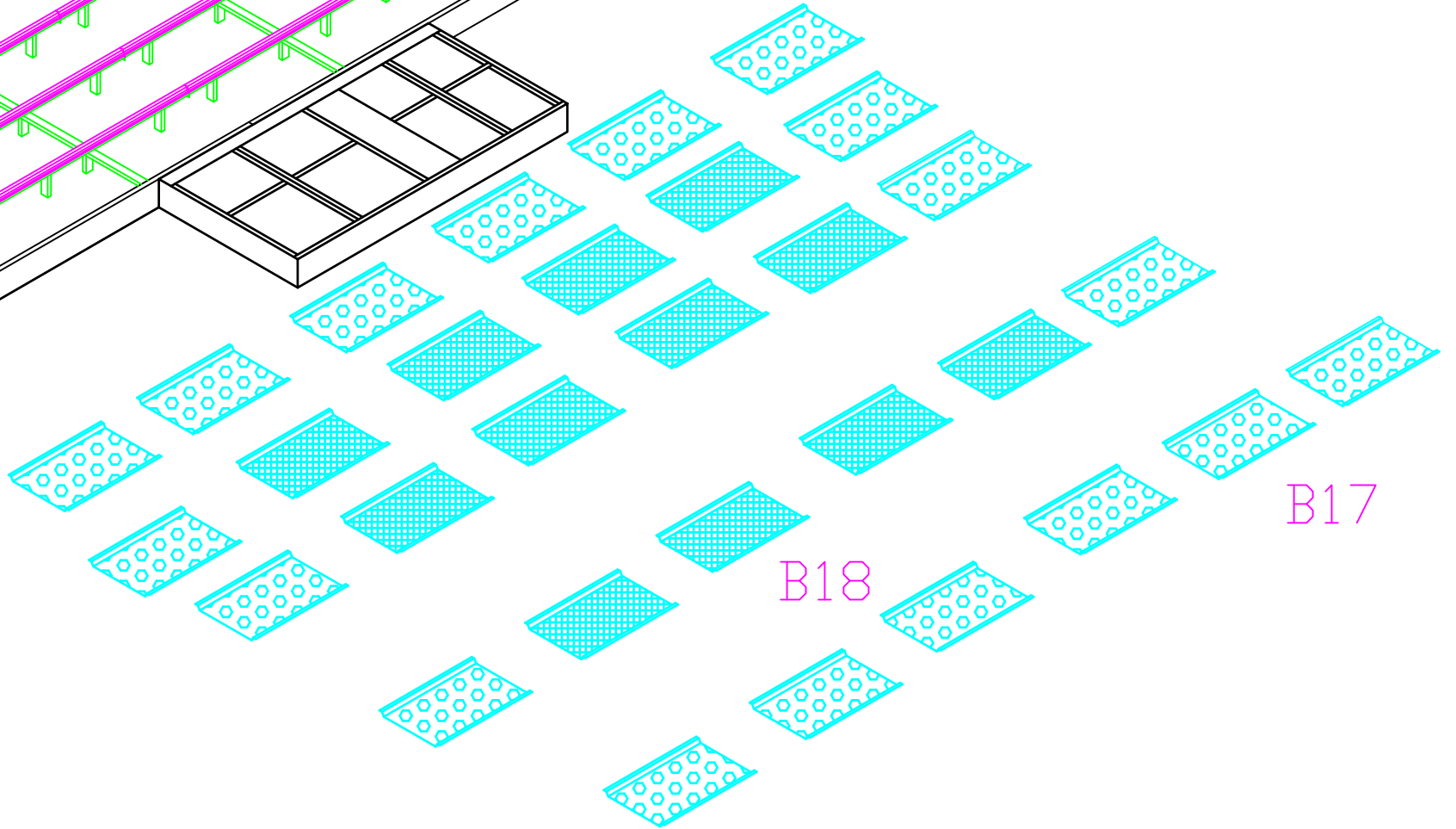
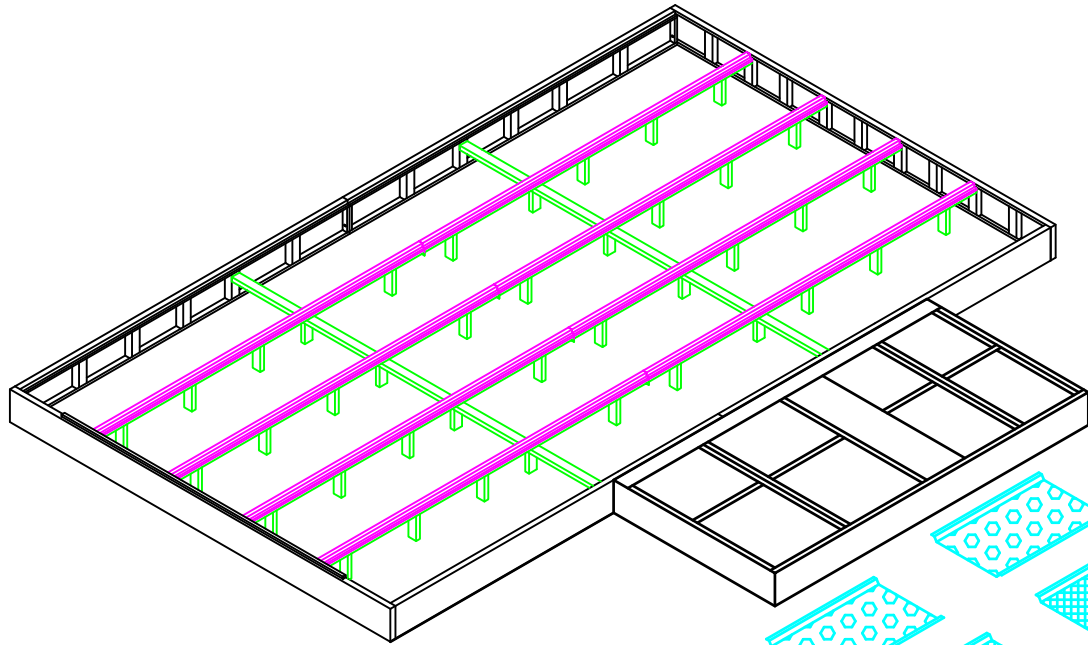

B18

B17

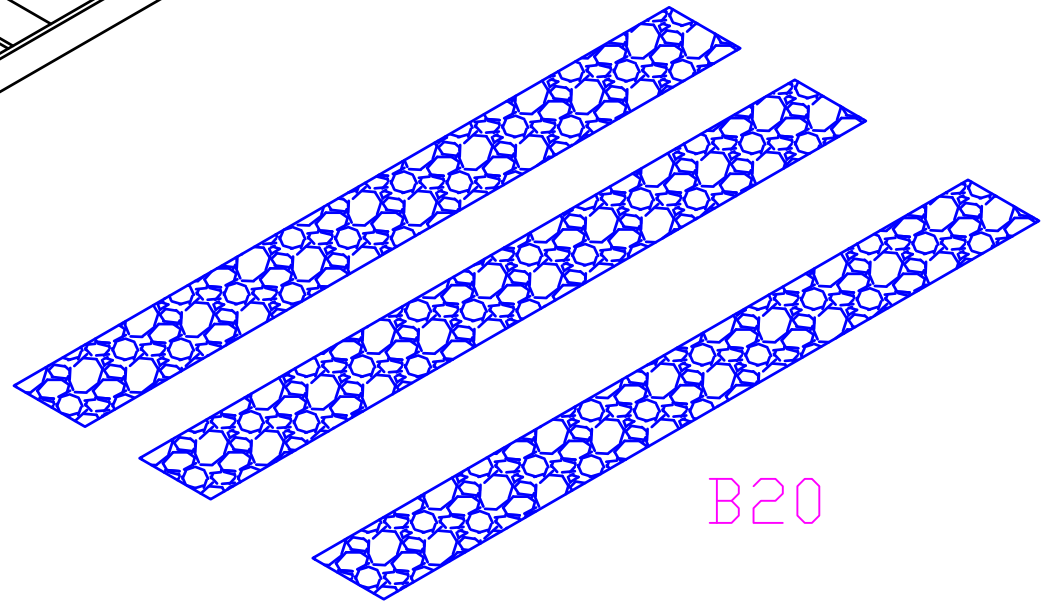
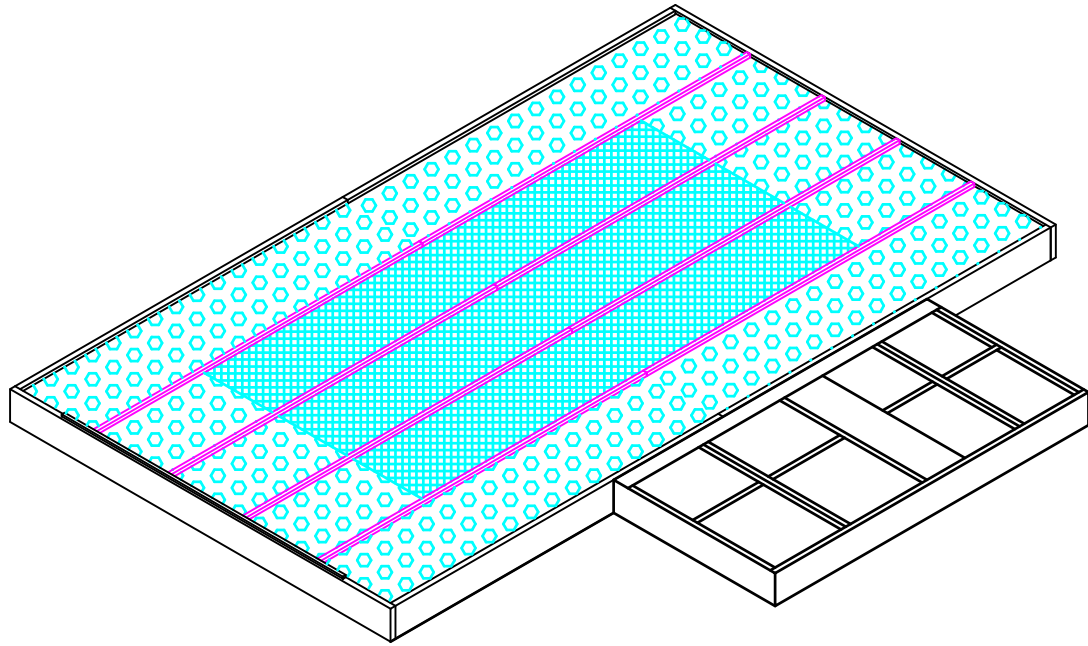

B20

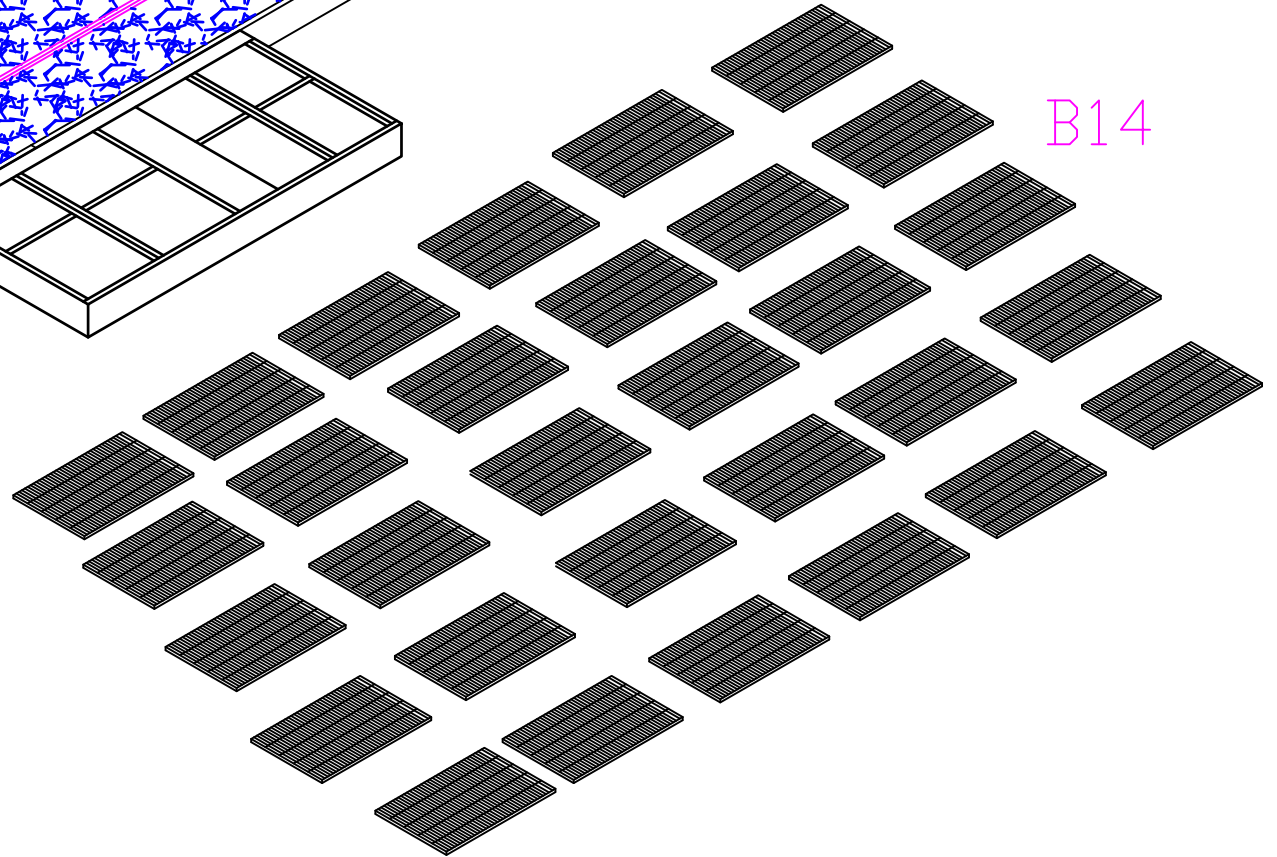
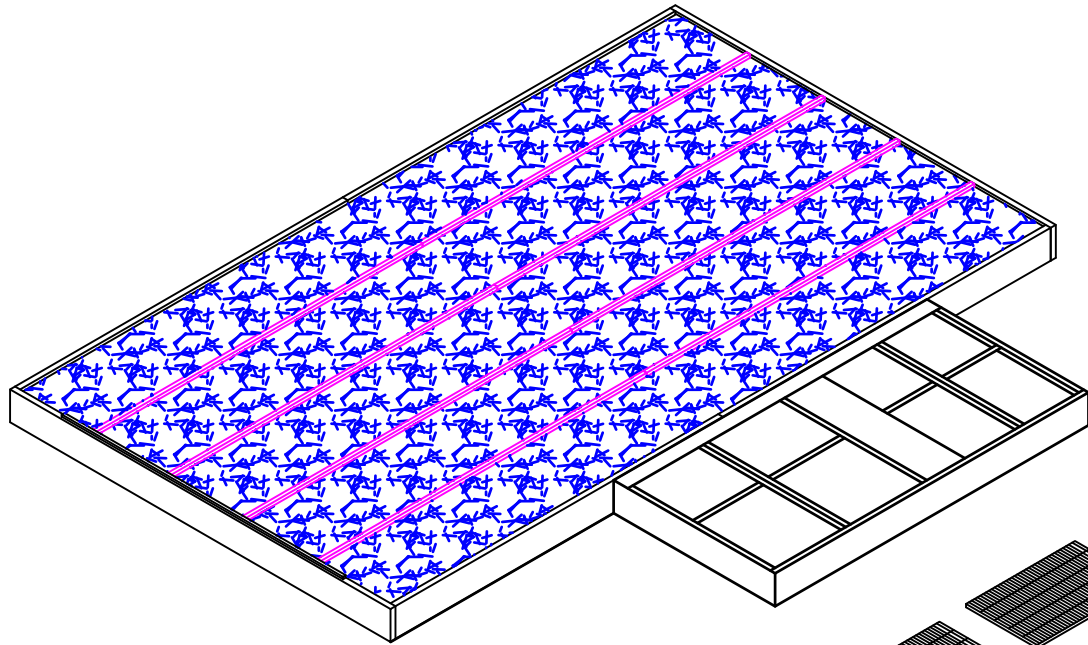

B14



B10-1

B10-2

B11

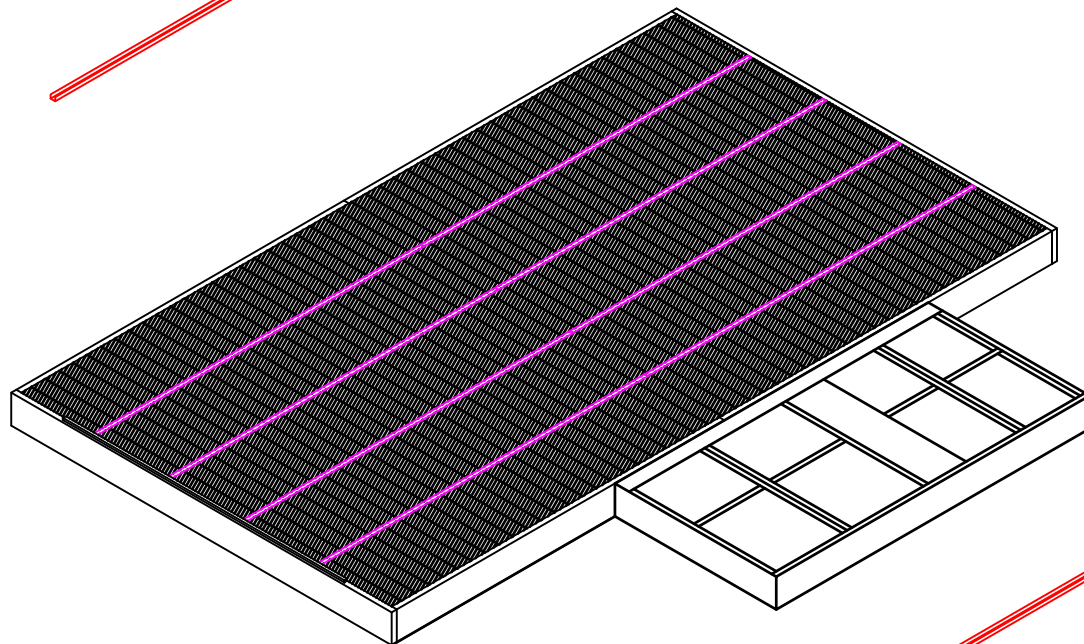

B10-2

B10-1

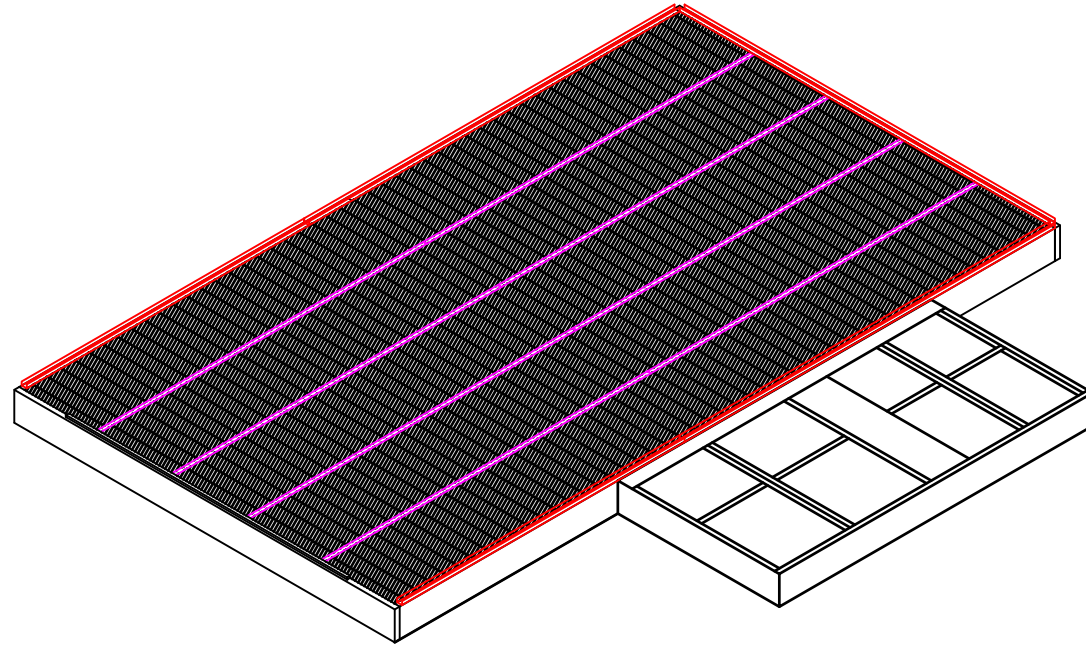

C9

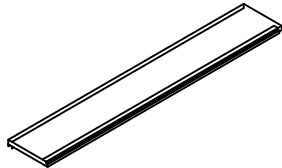

C11

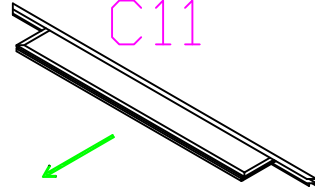

C10

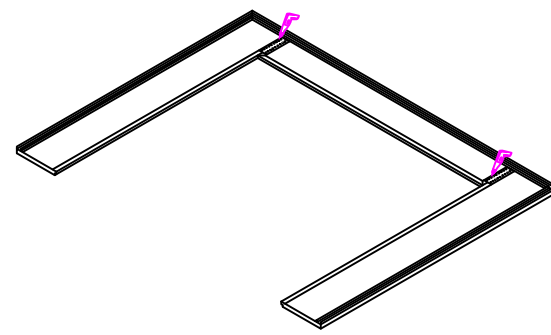
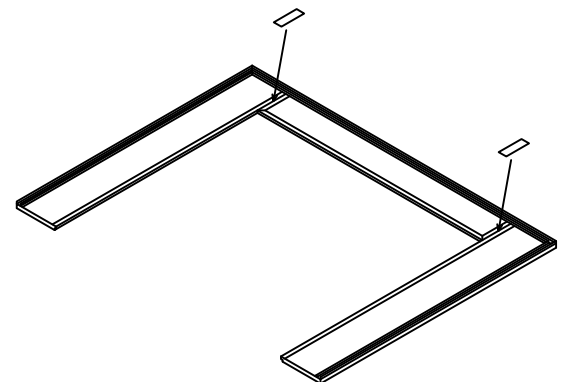
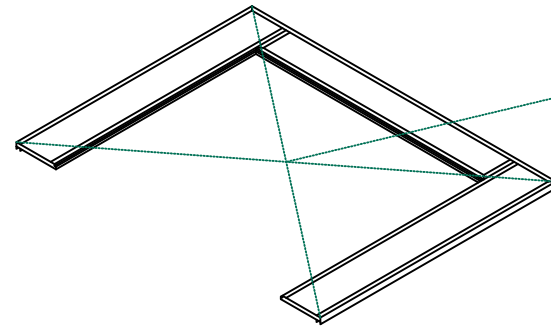
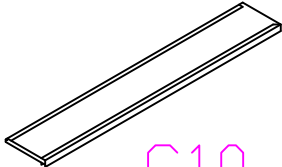

011

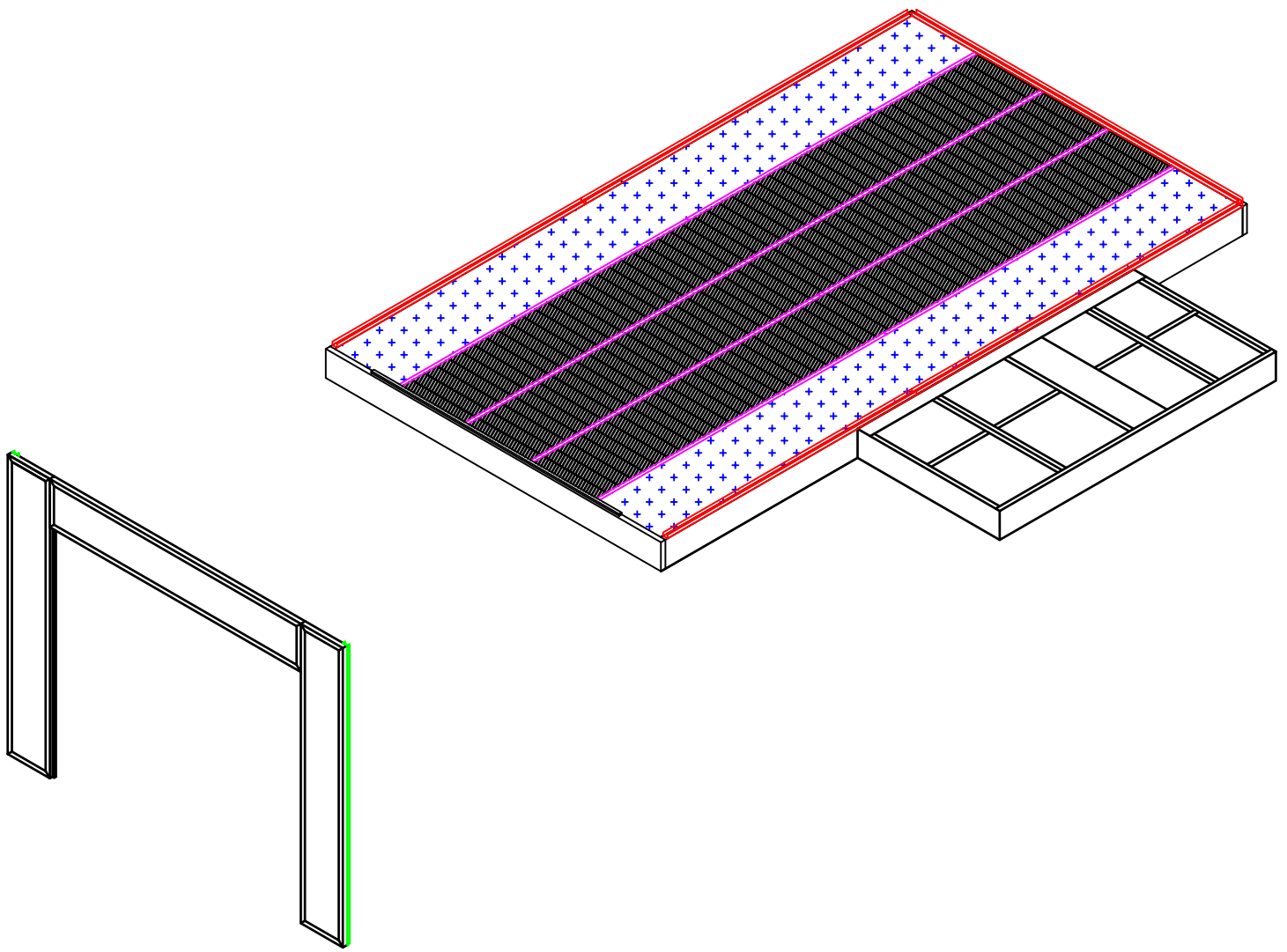

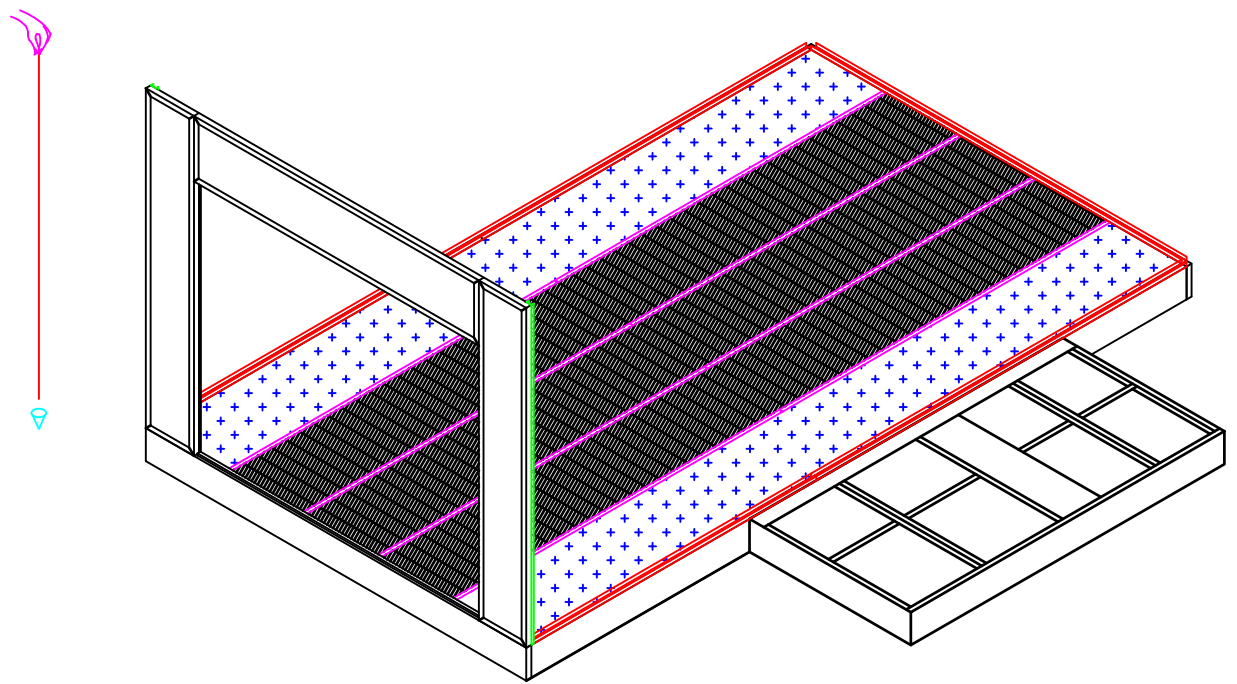

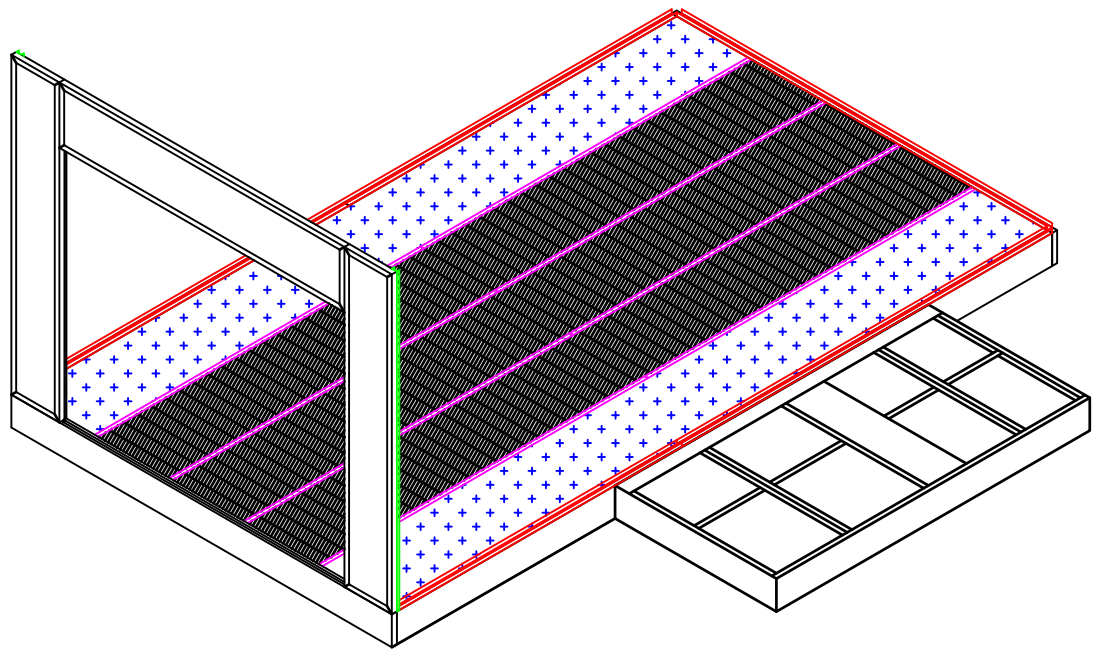

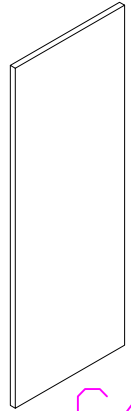

C4

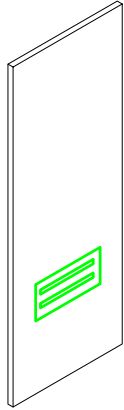
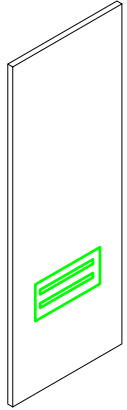

C2

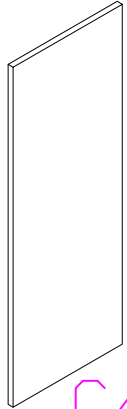
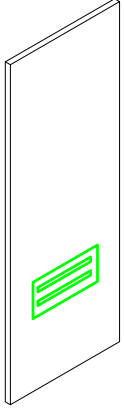
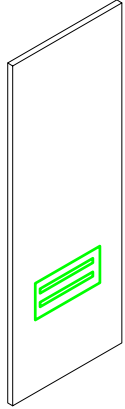

C4

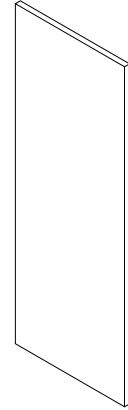
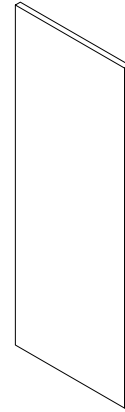

C4

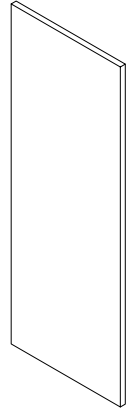

C5

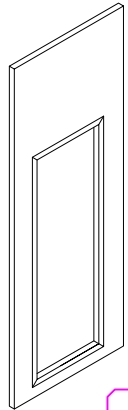
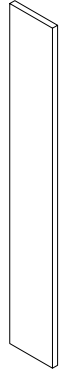

C1

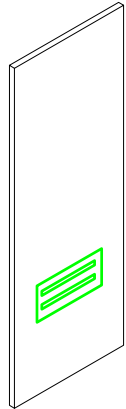
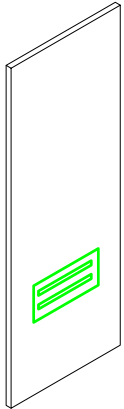

C3

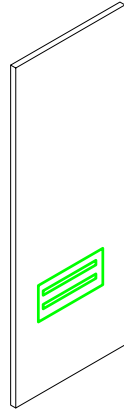
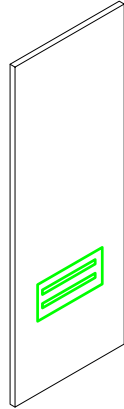

C4

015

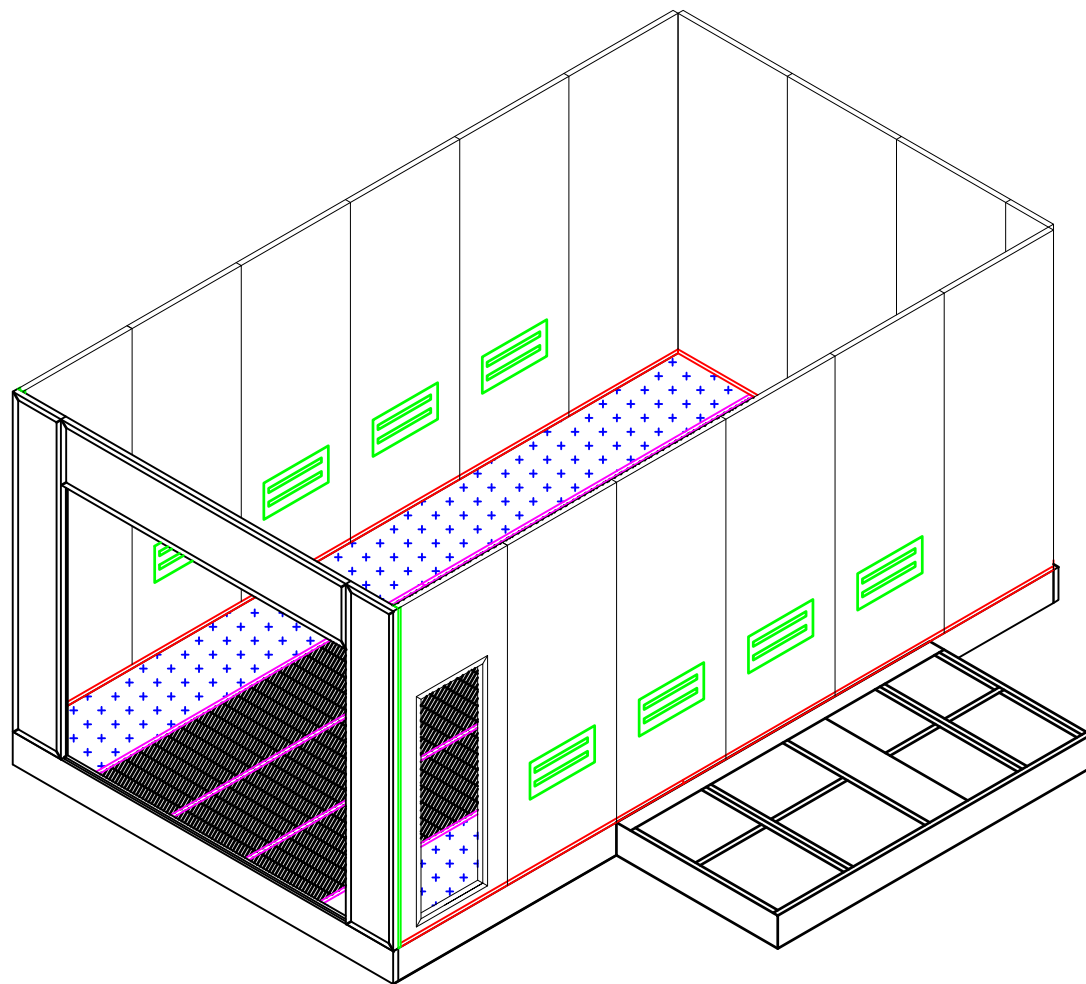



open the intake air mouth 1445×405mm, it will align at with cabinet

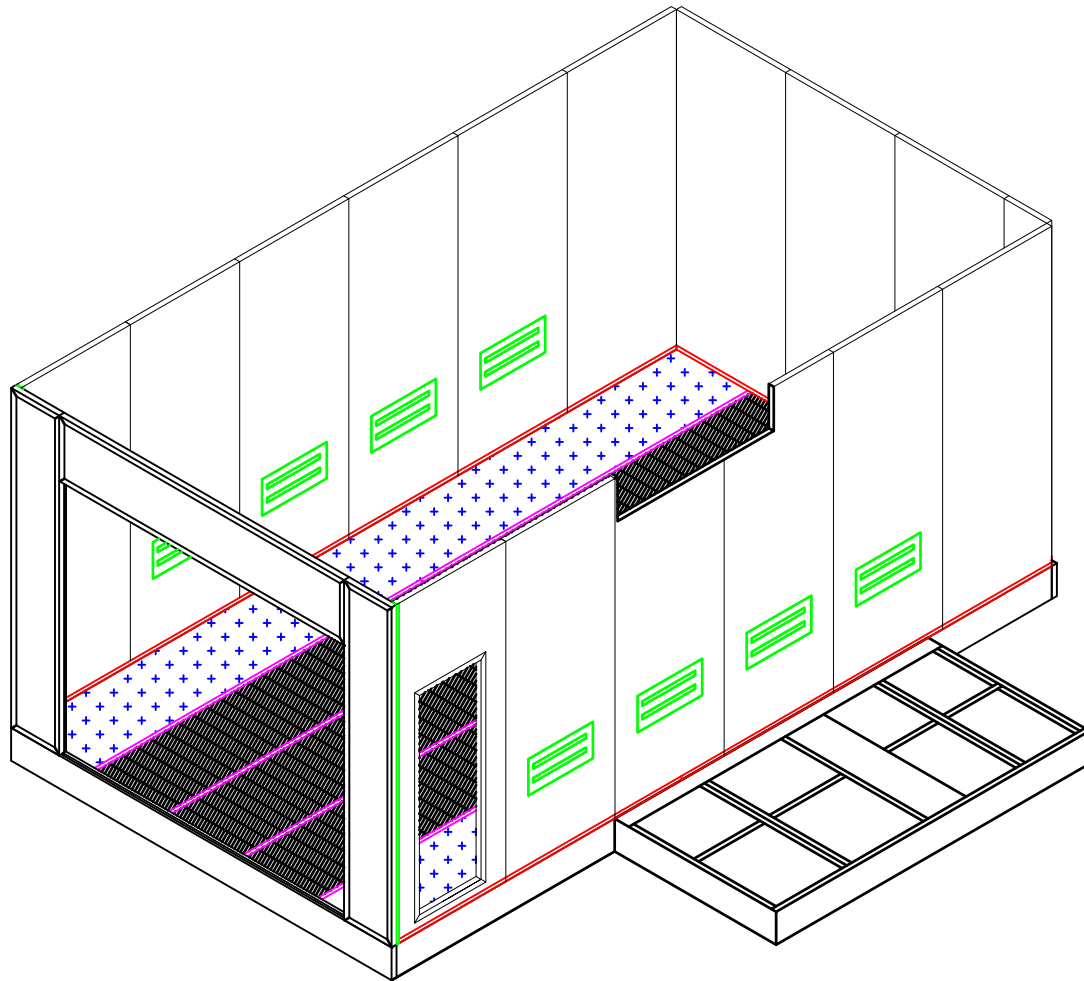

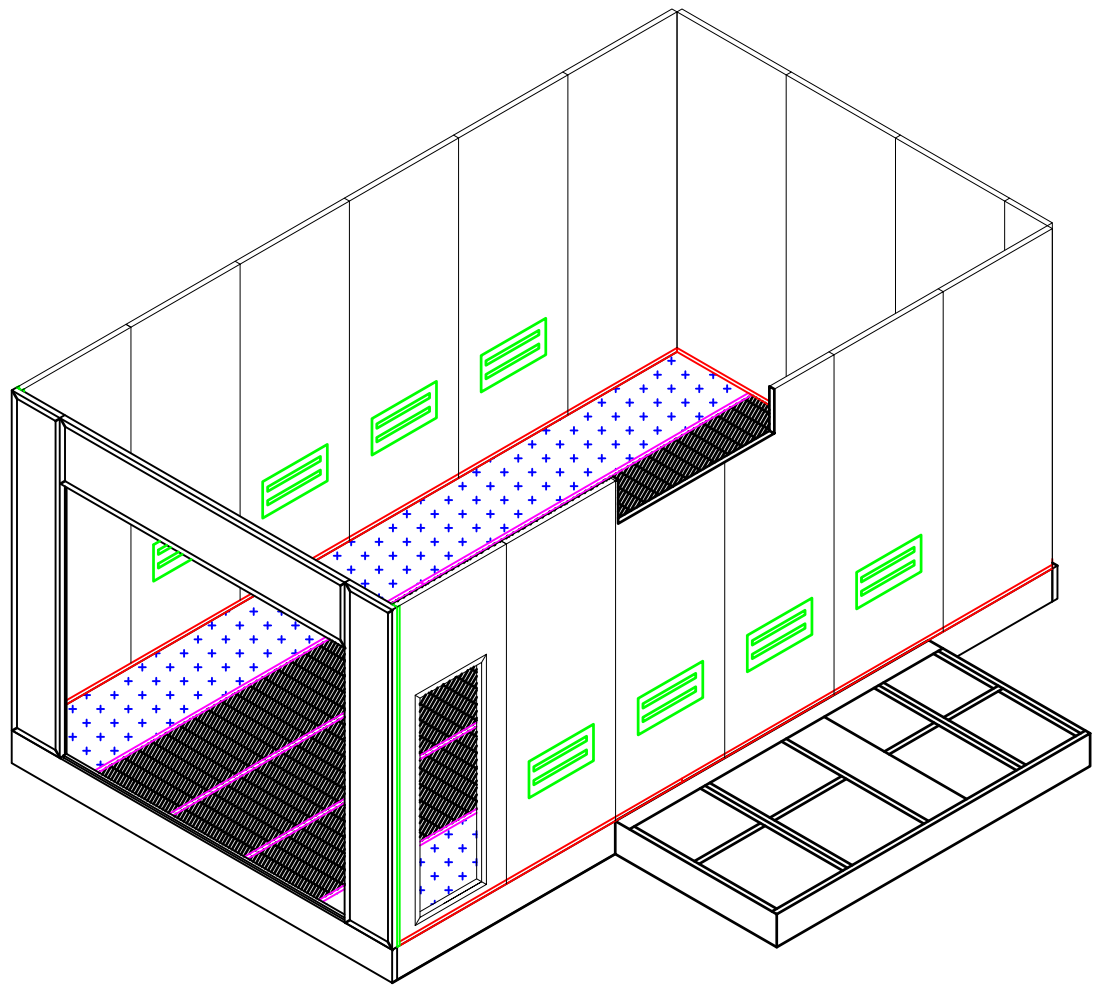

C12

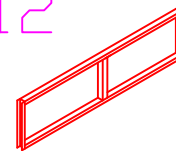

018

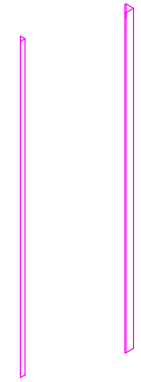
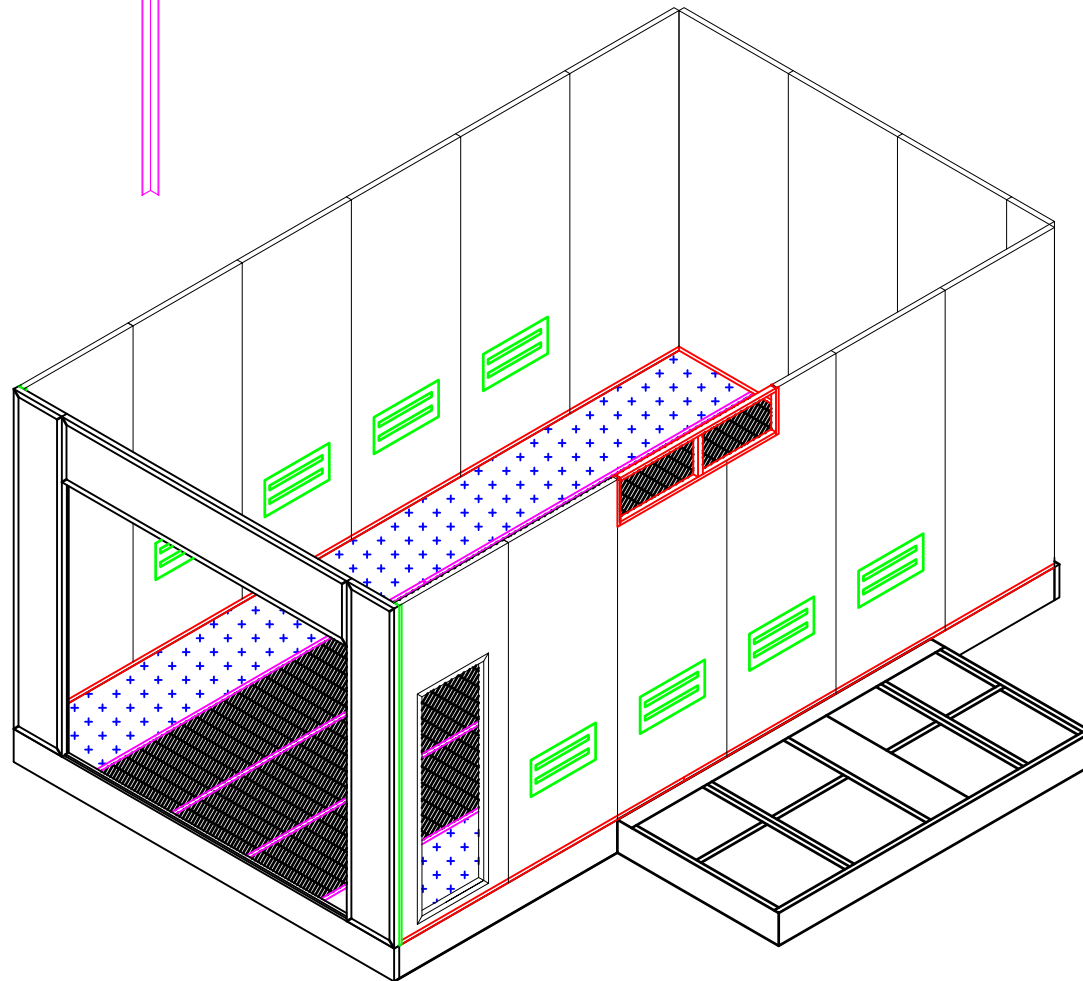

C14 C13

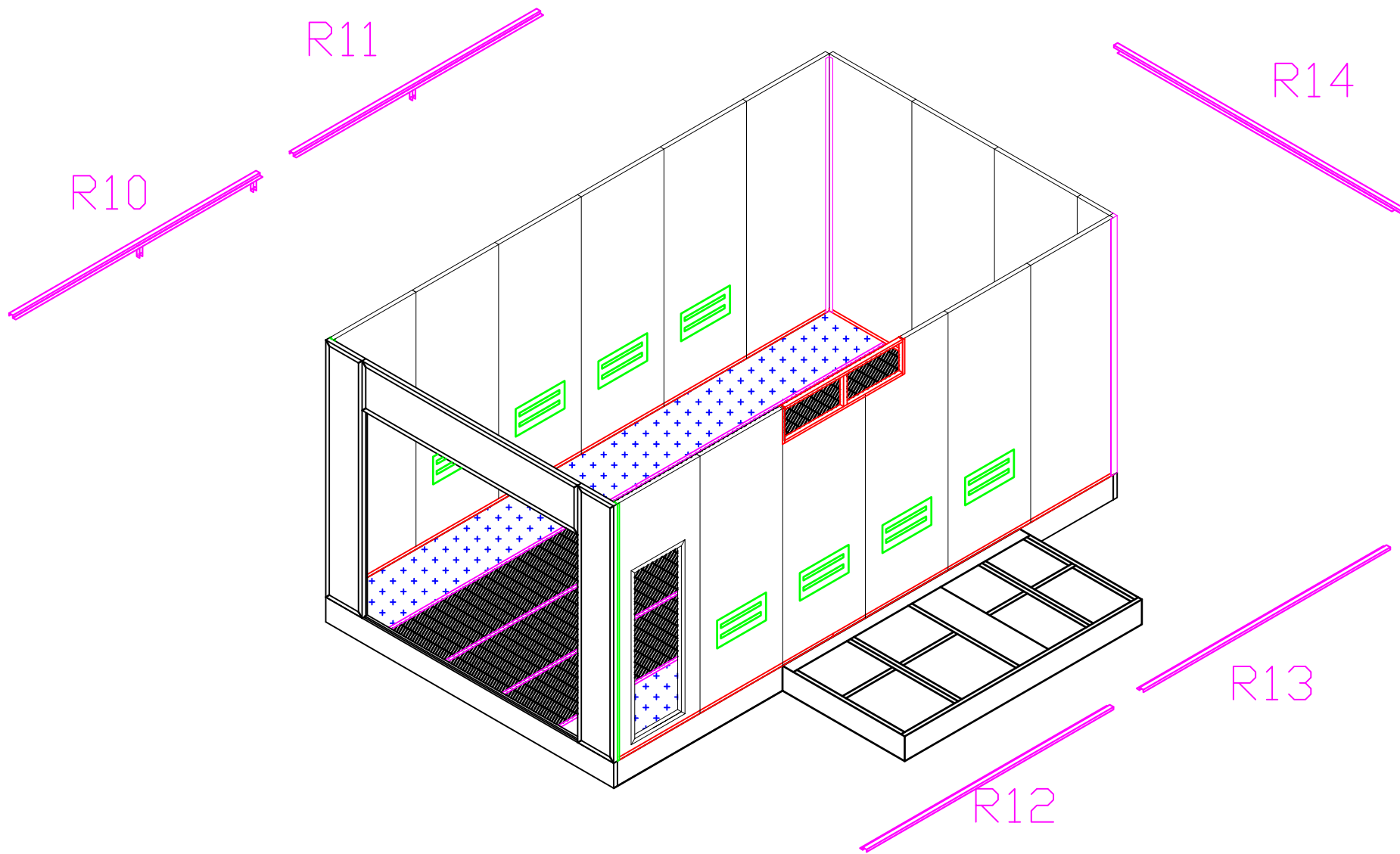

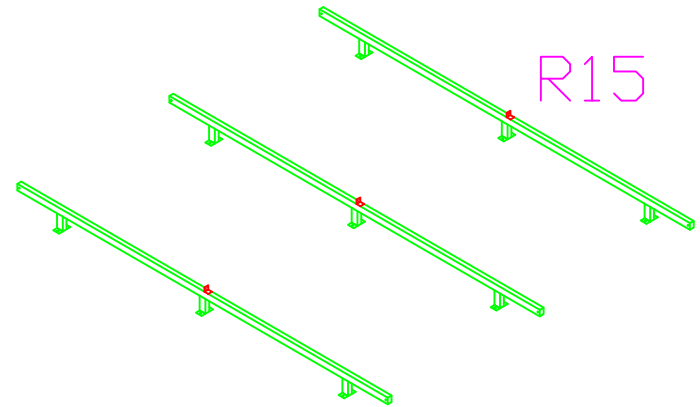
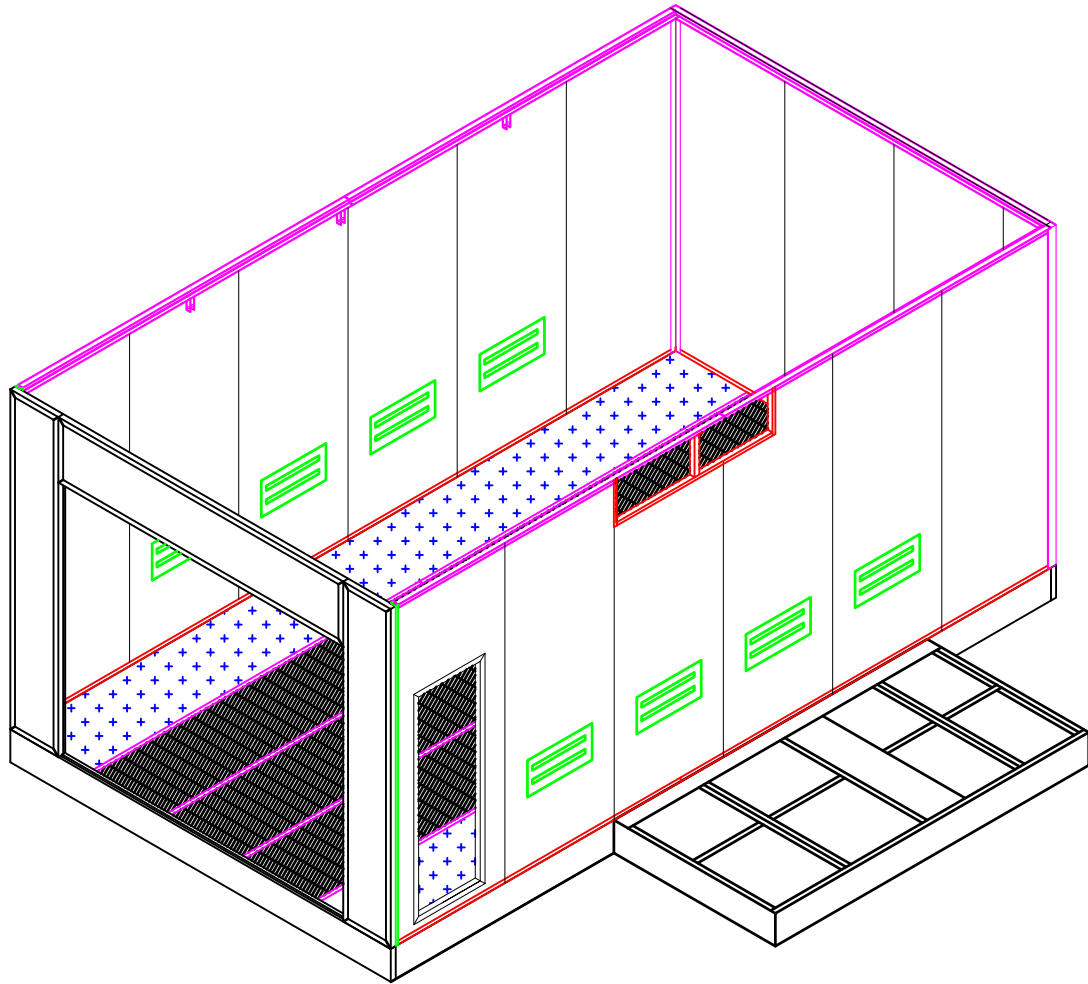

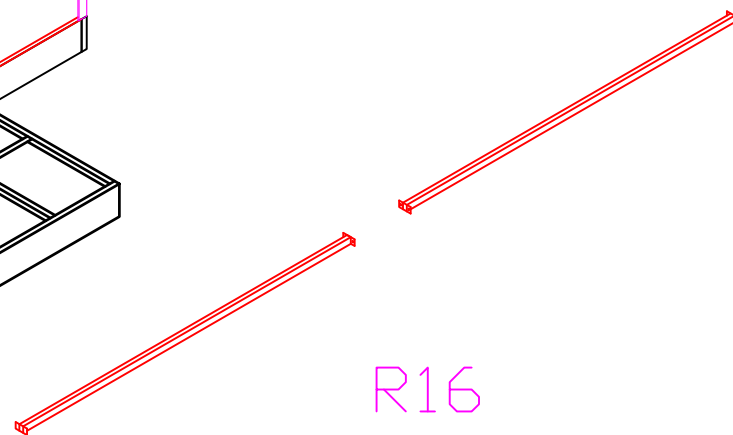
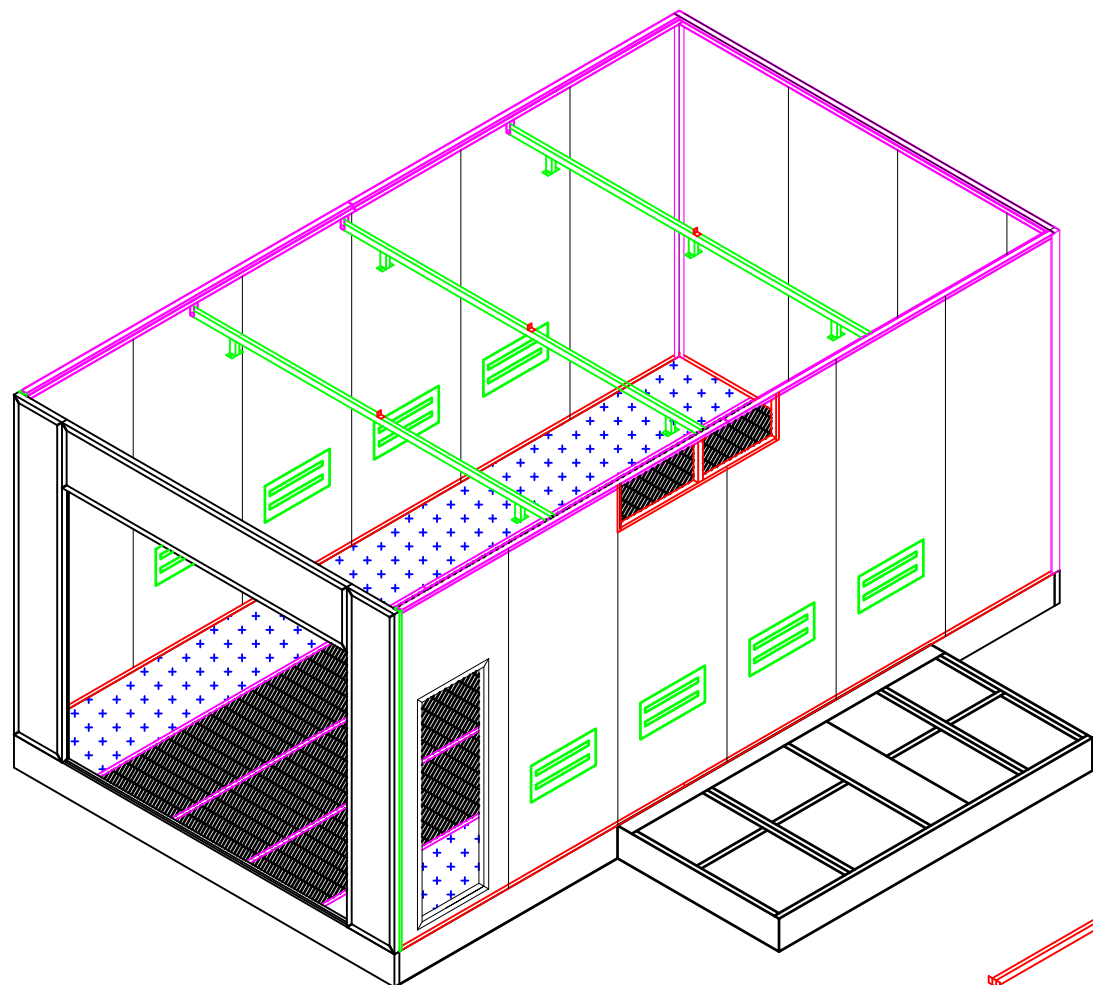

R16

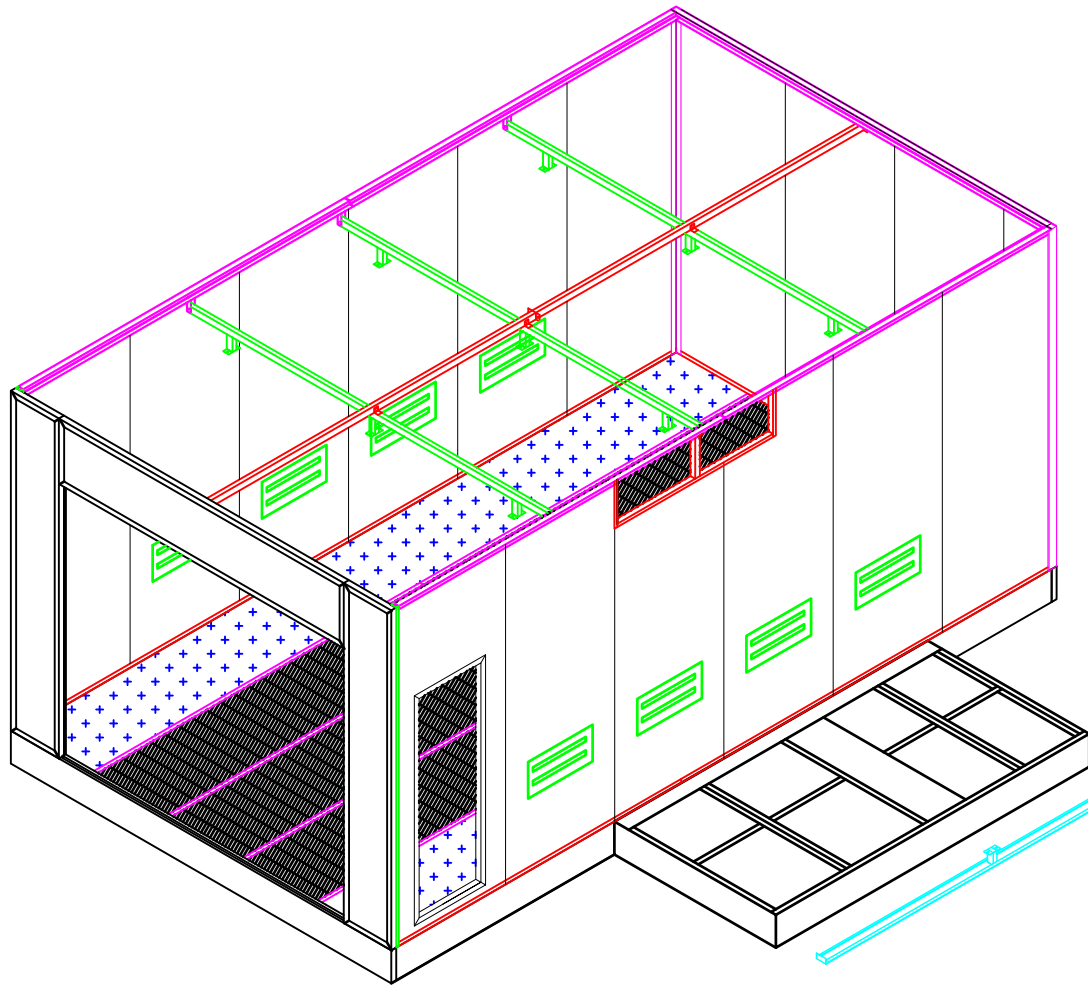

R5

R3

R6

R4

R6

R5

023

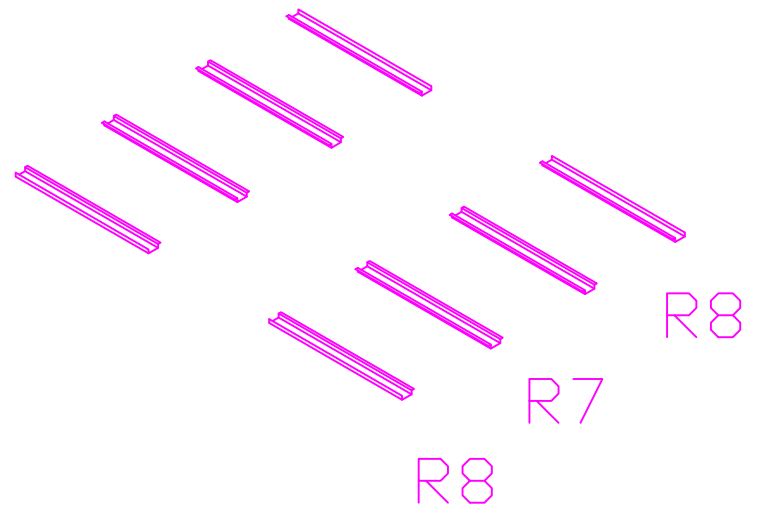
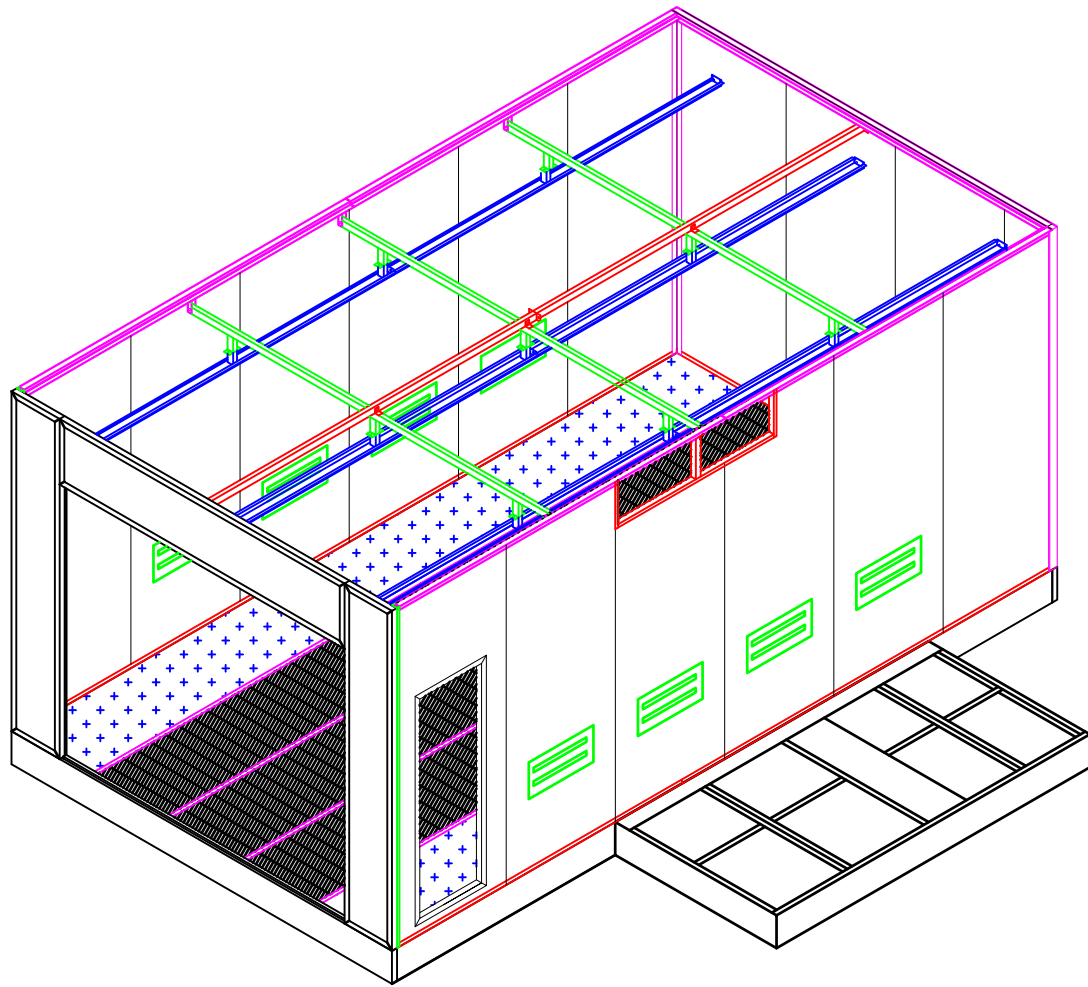



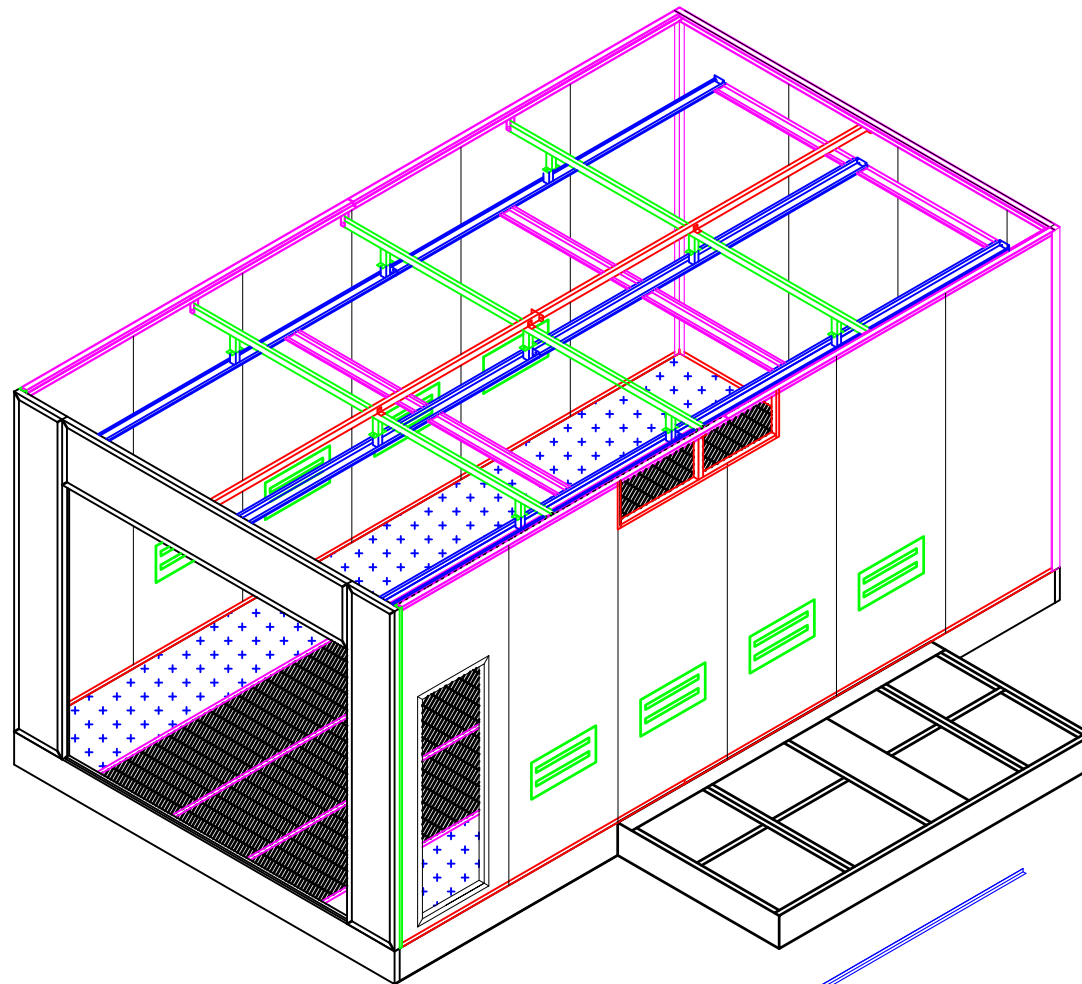

R2

025

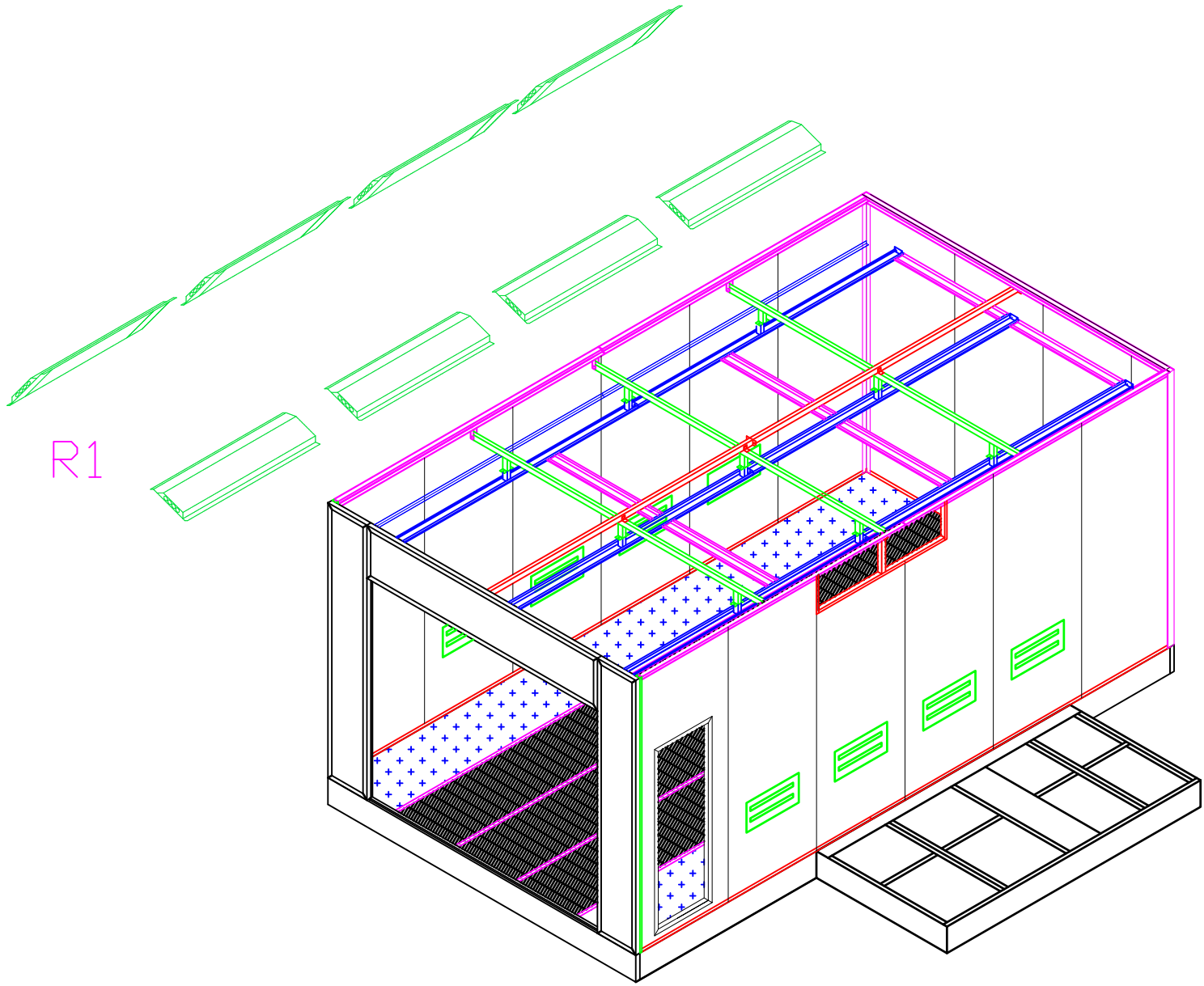

R1

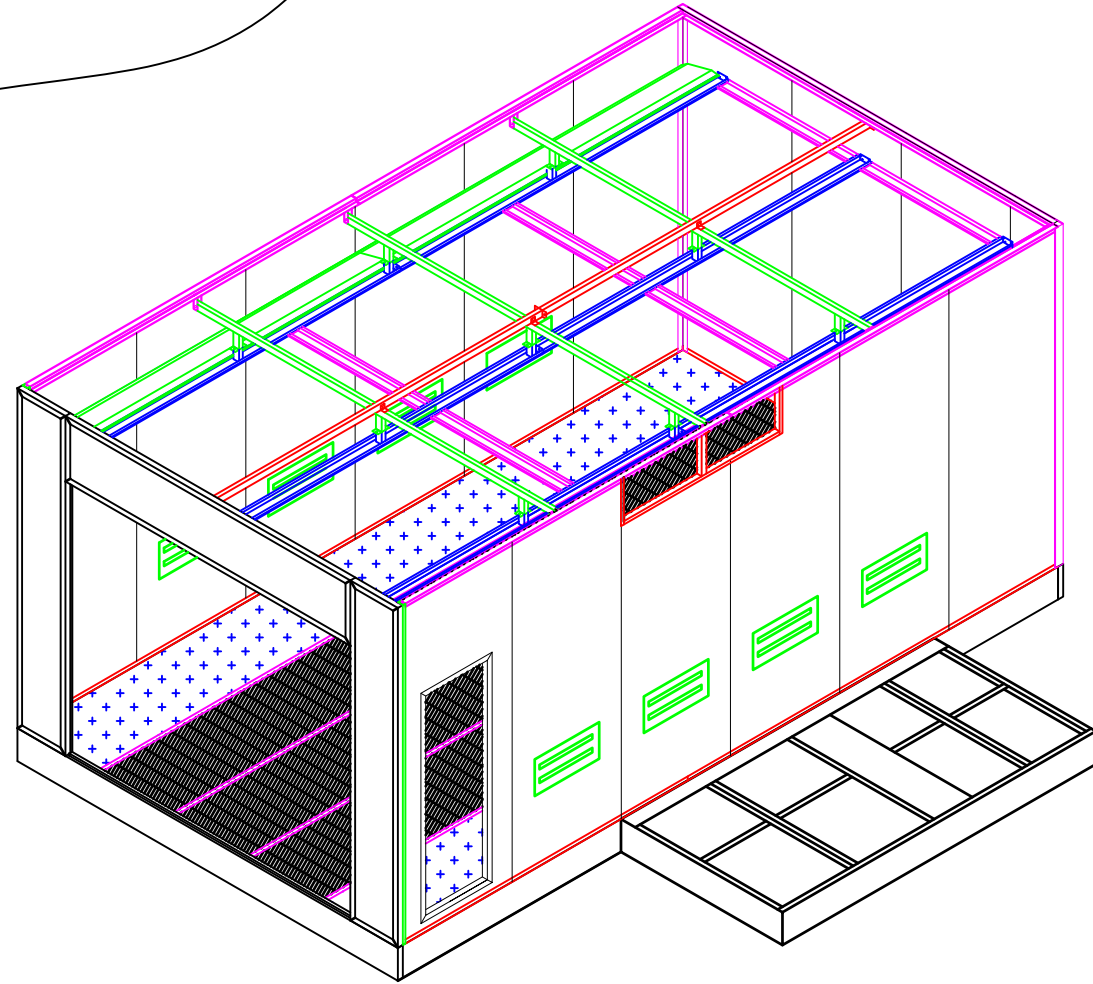
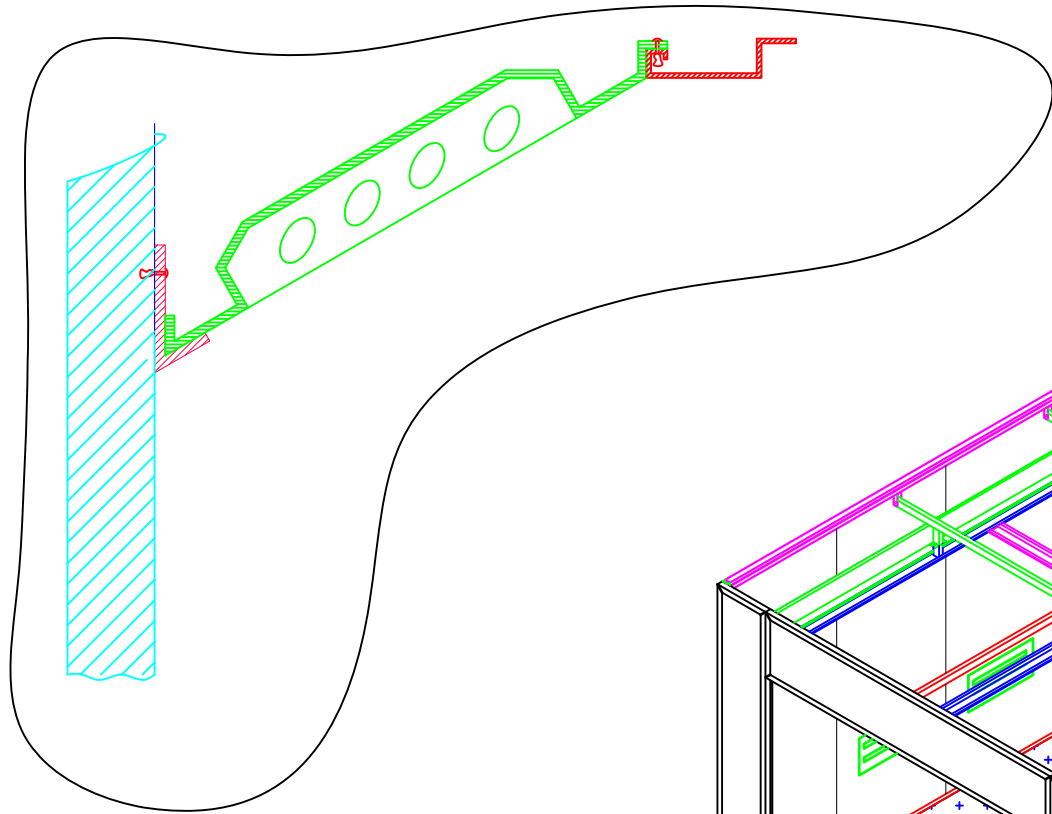

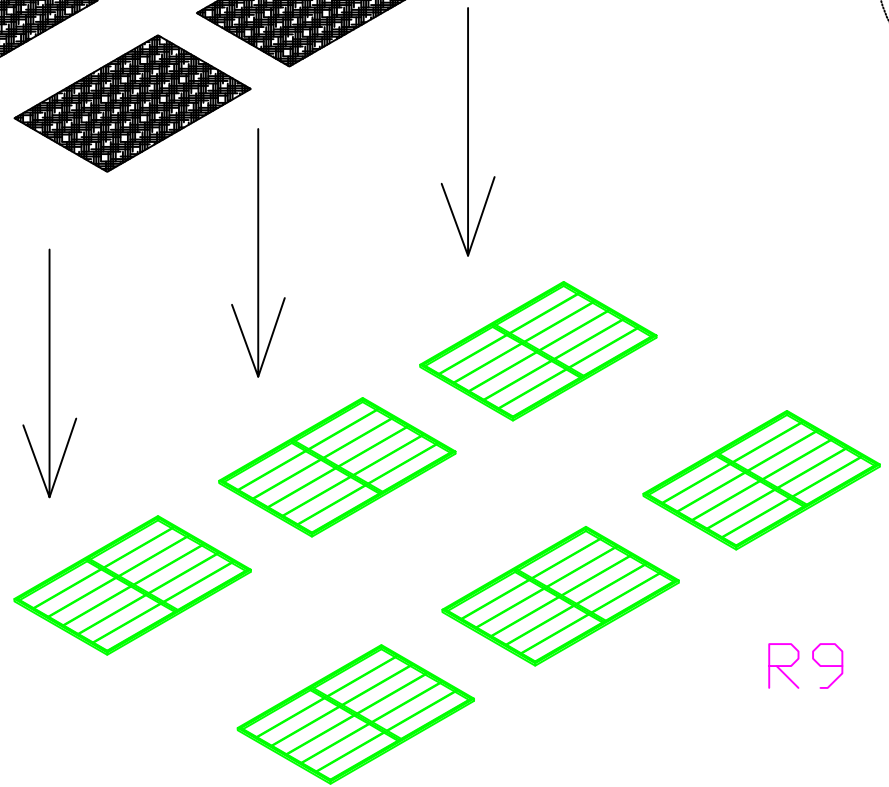
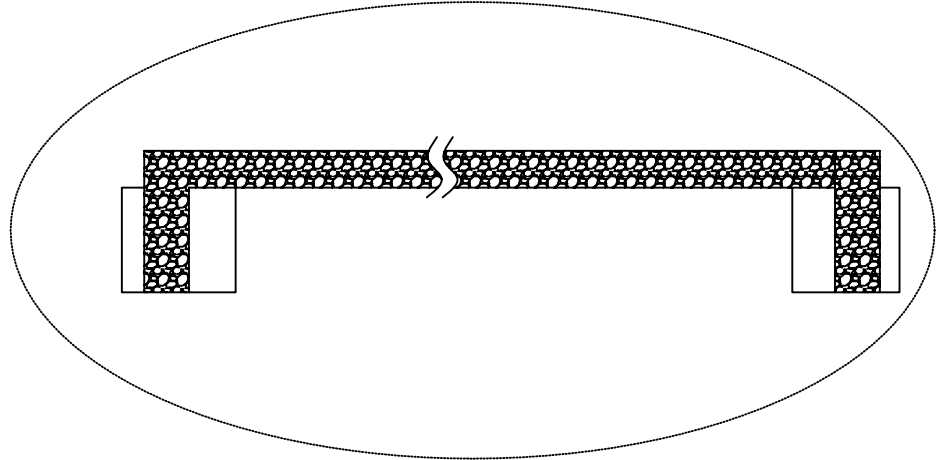
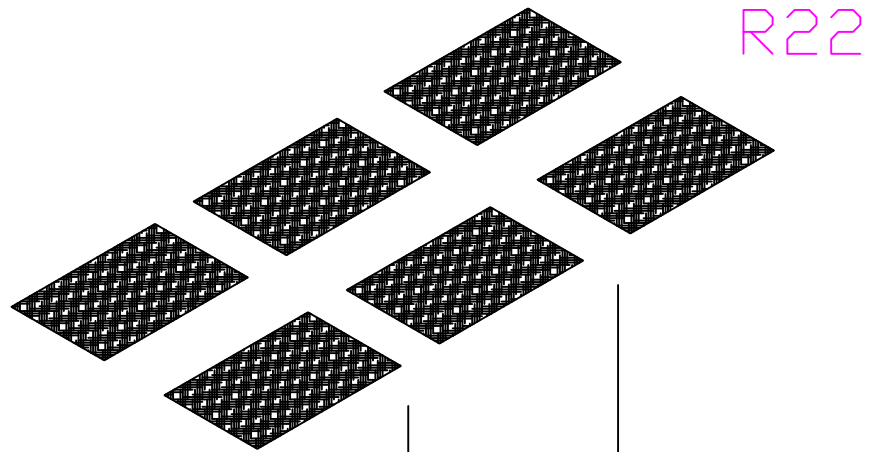

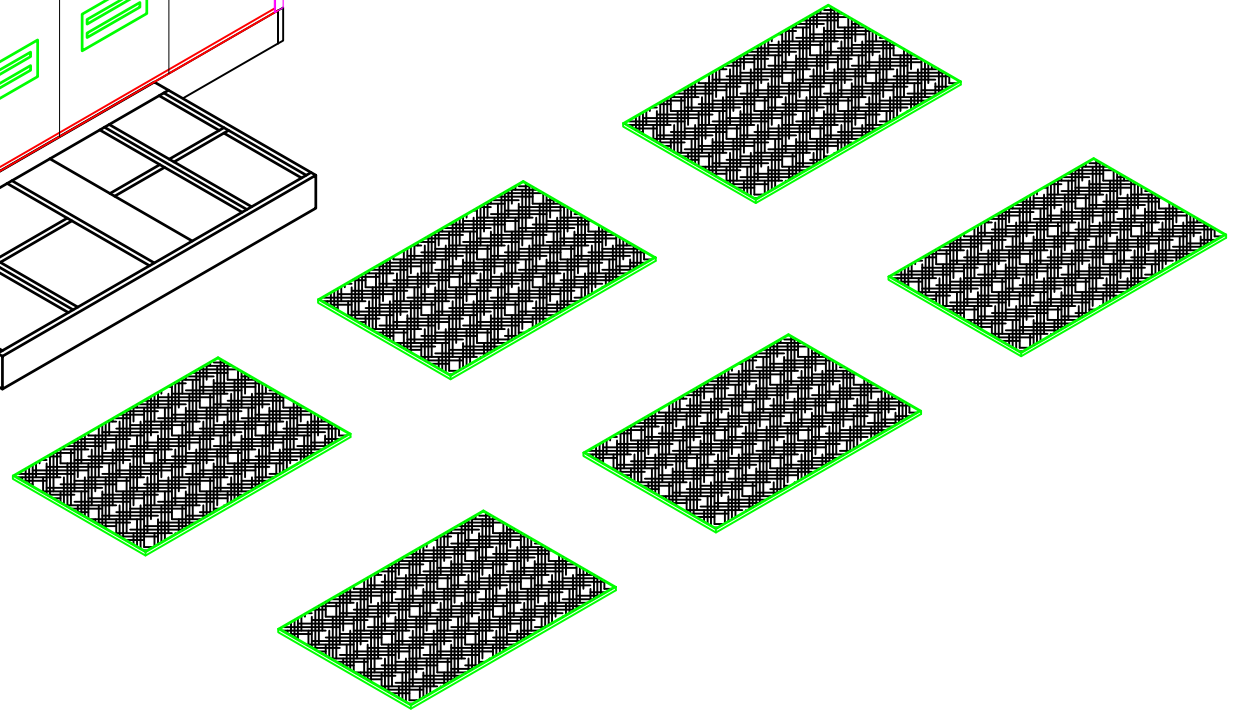
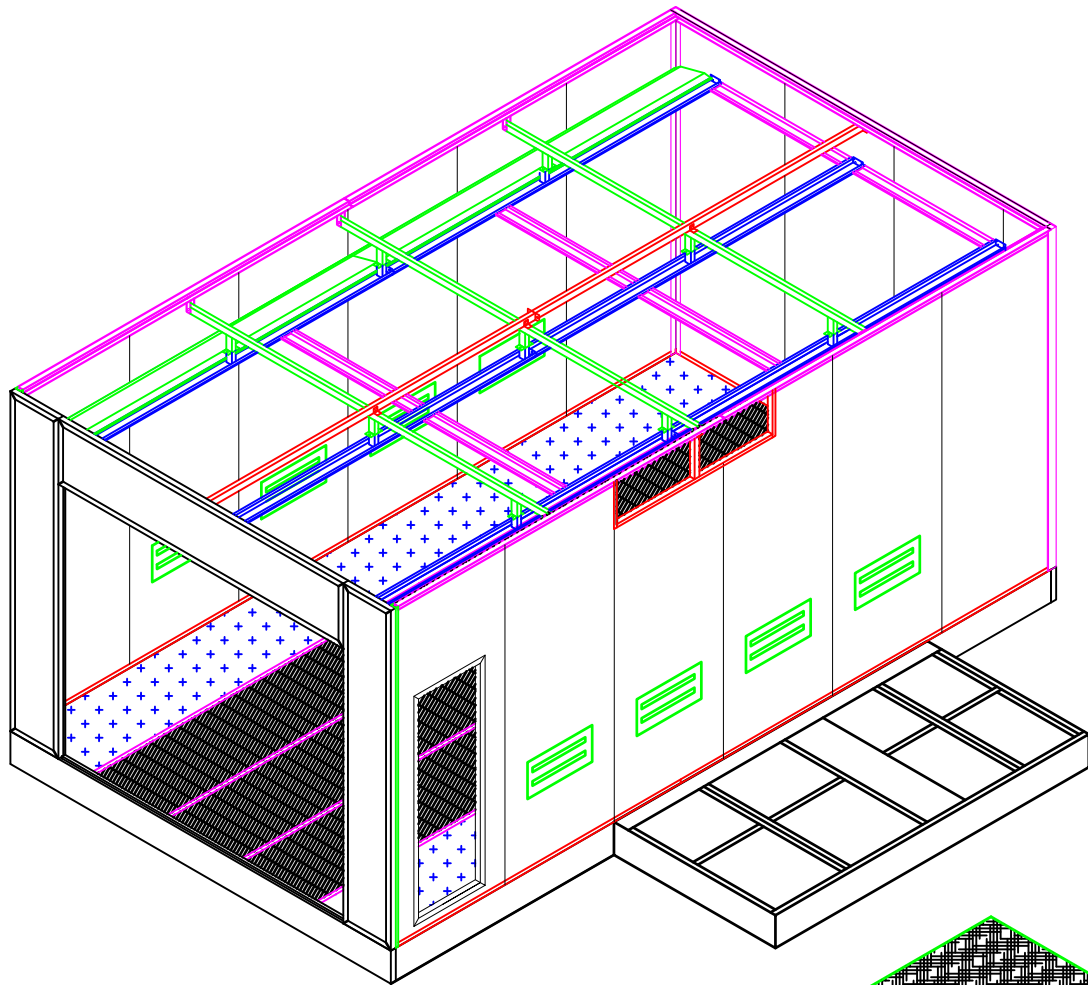

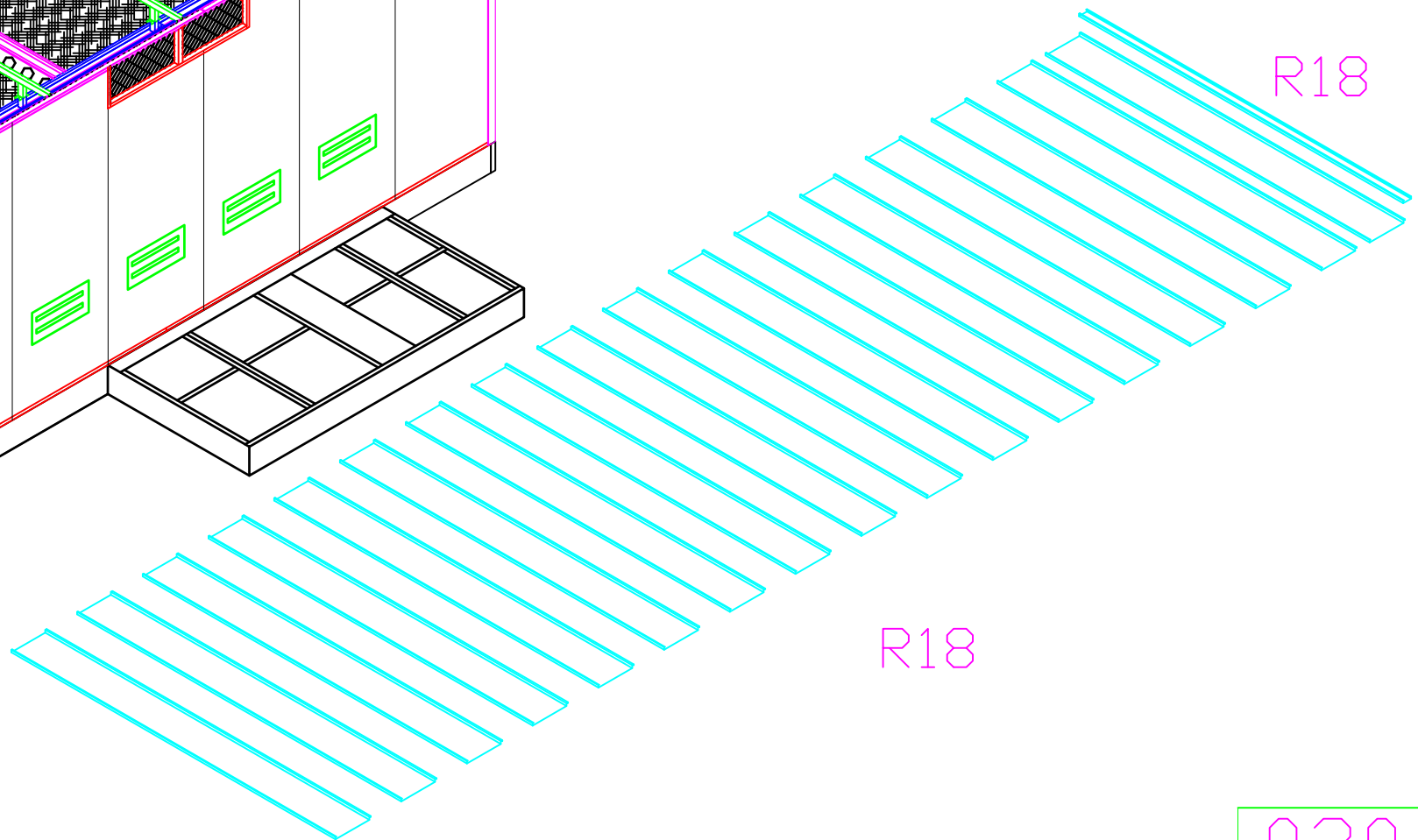
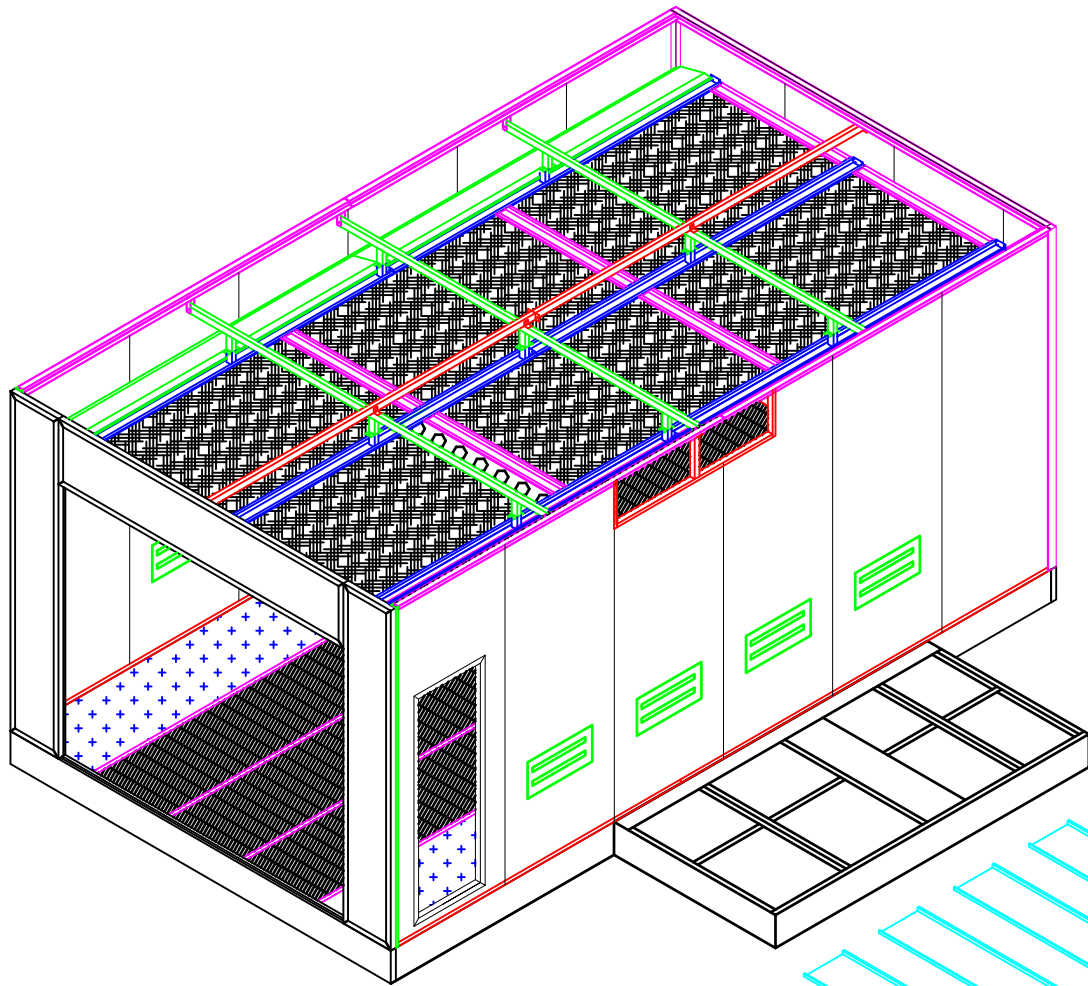

R18

R18

030

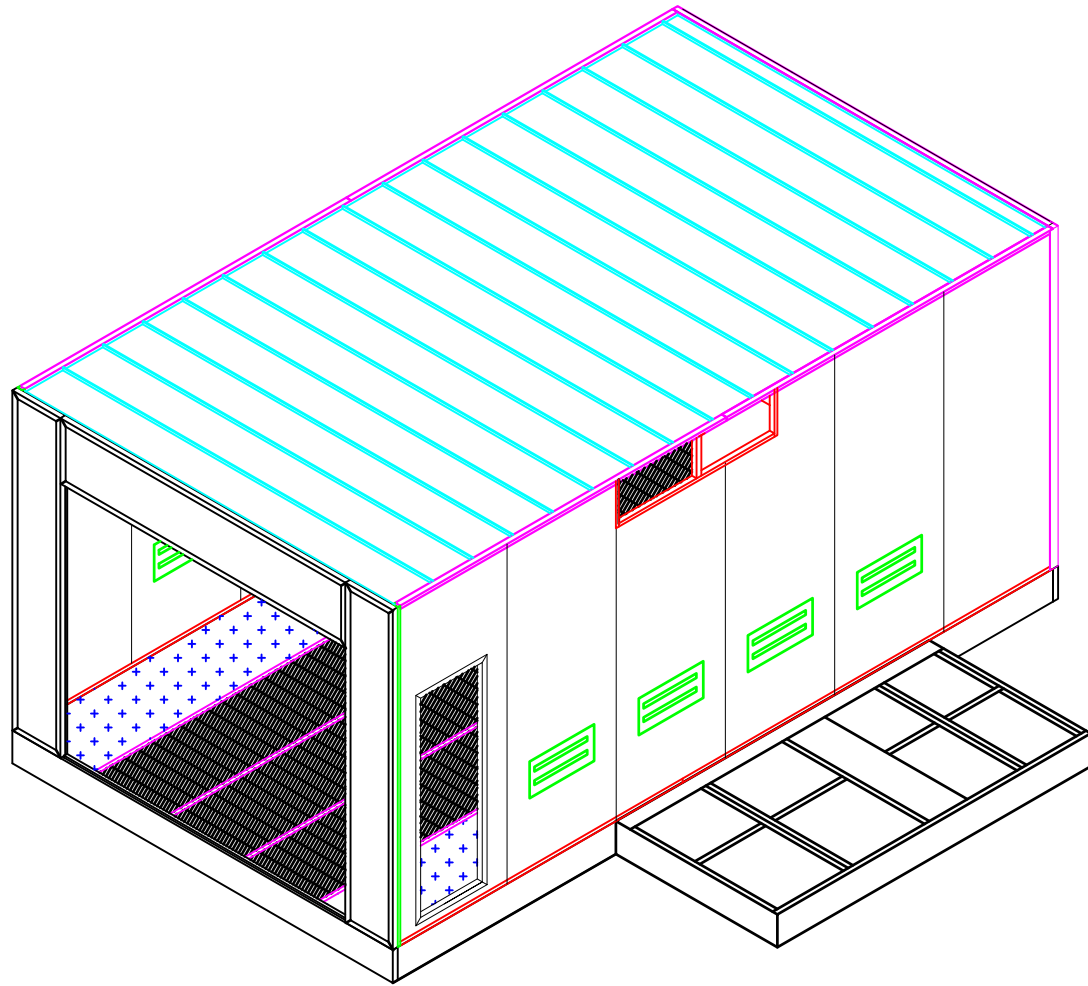

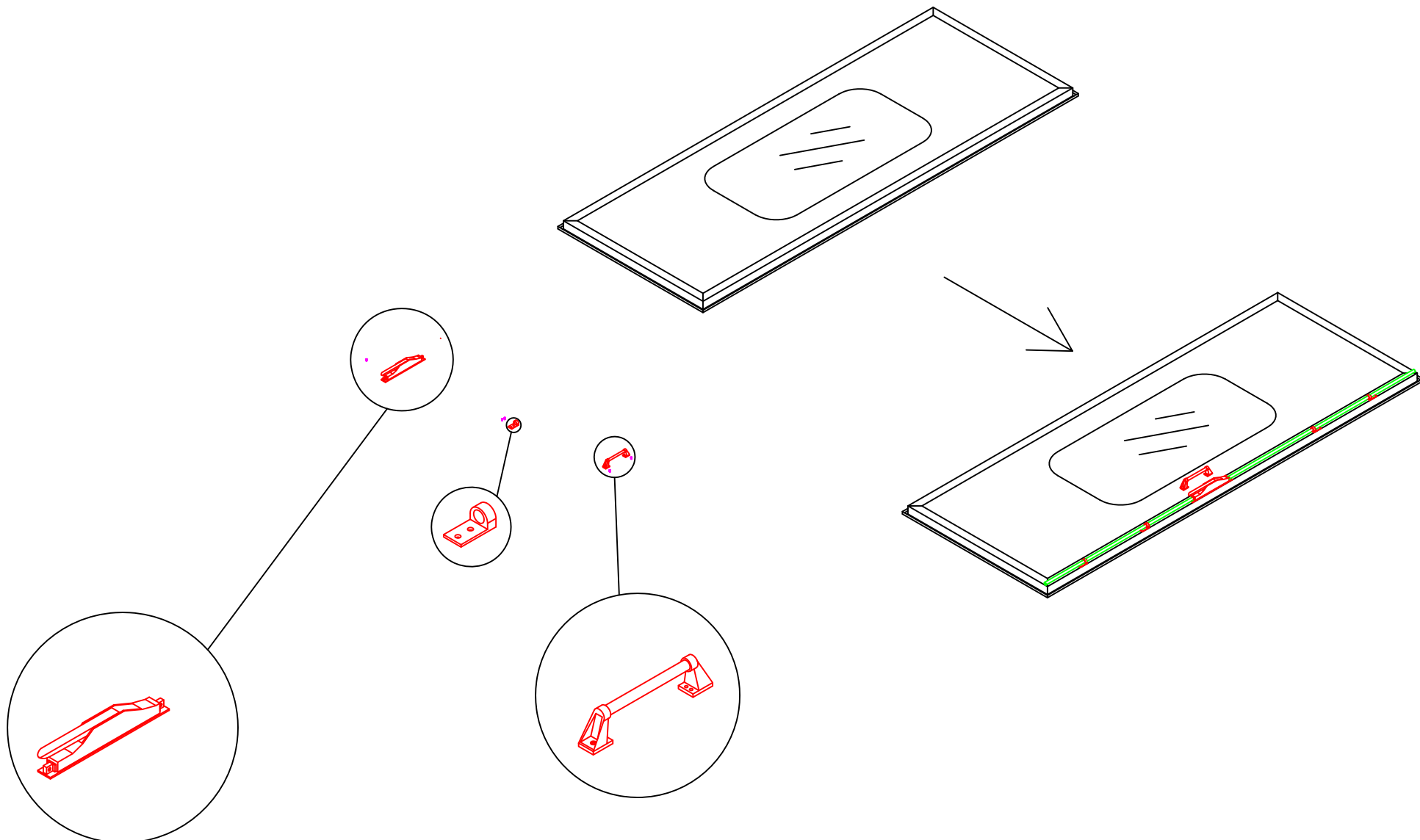



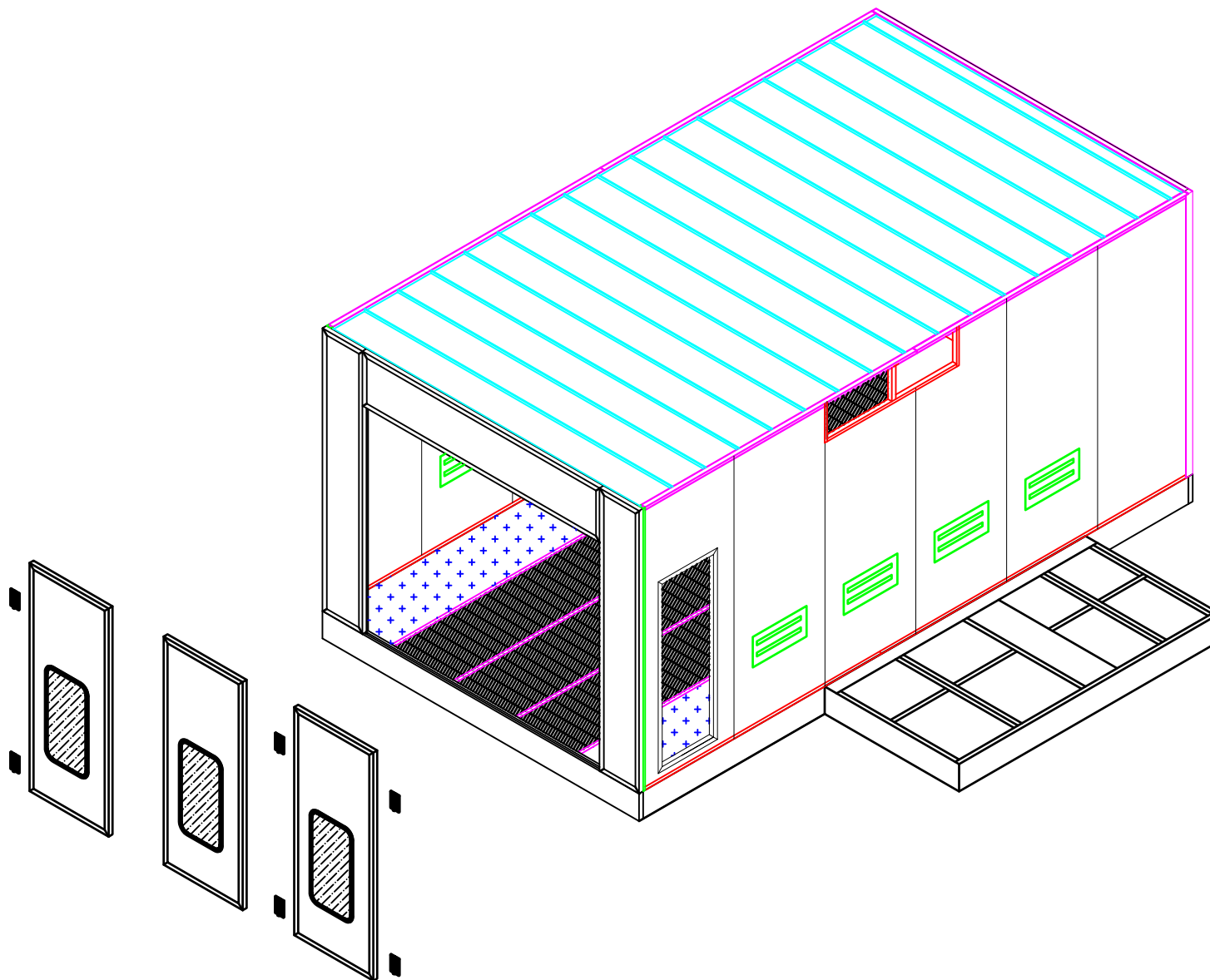

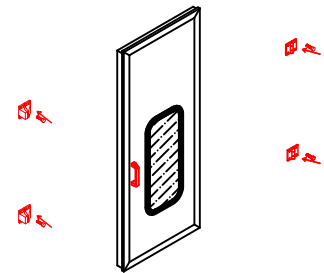
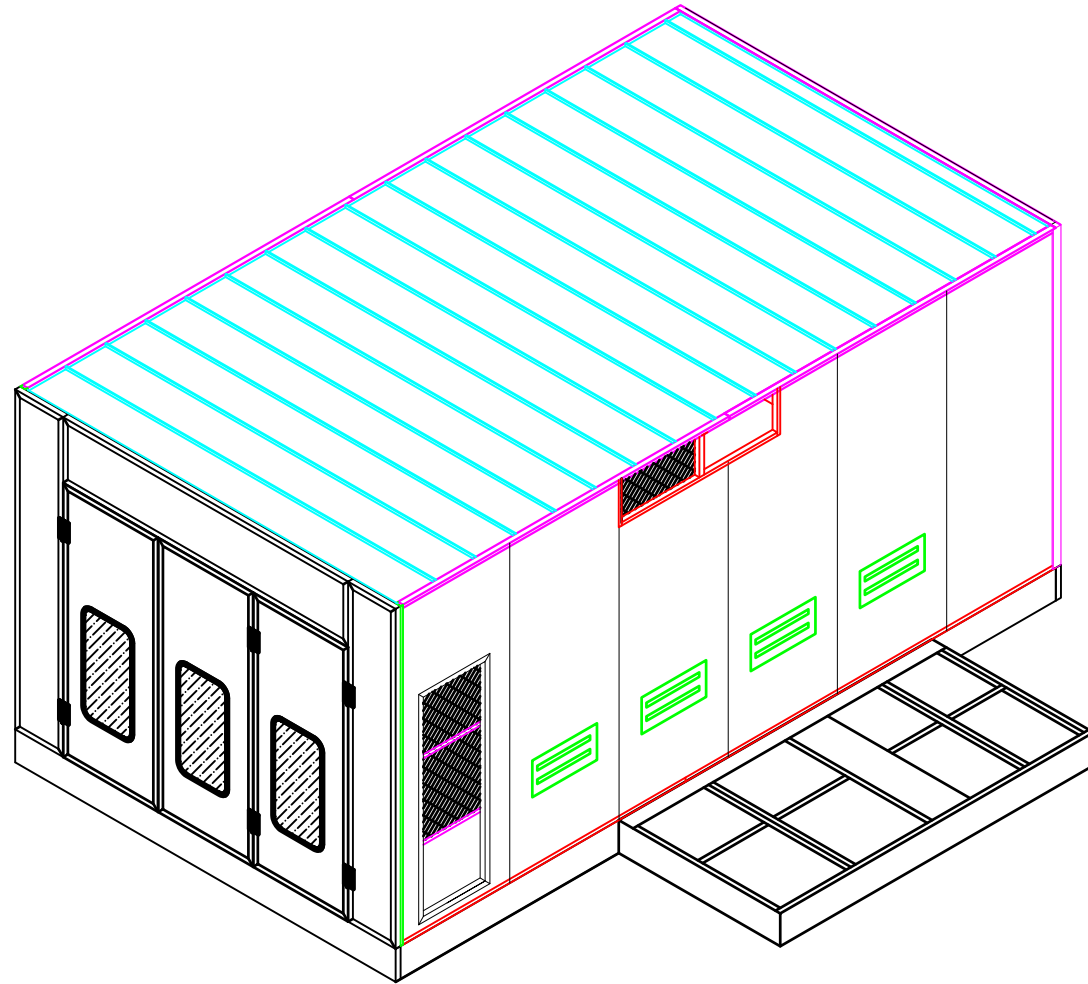

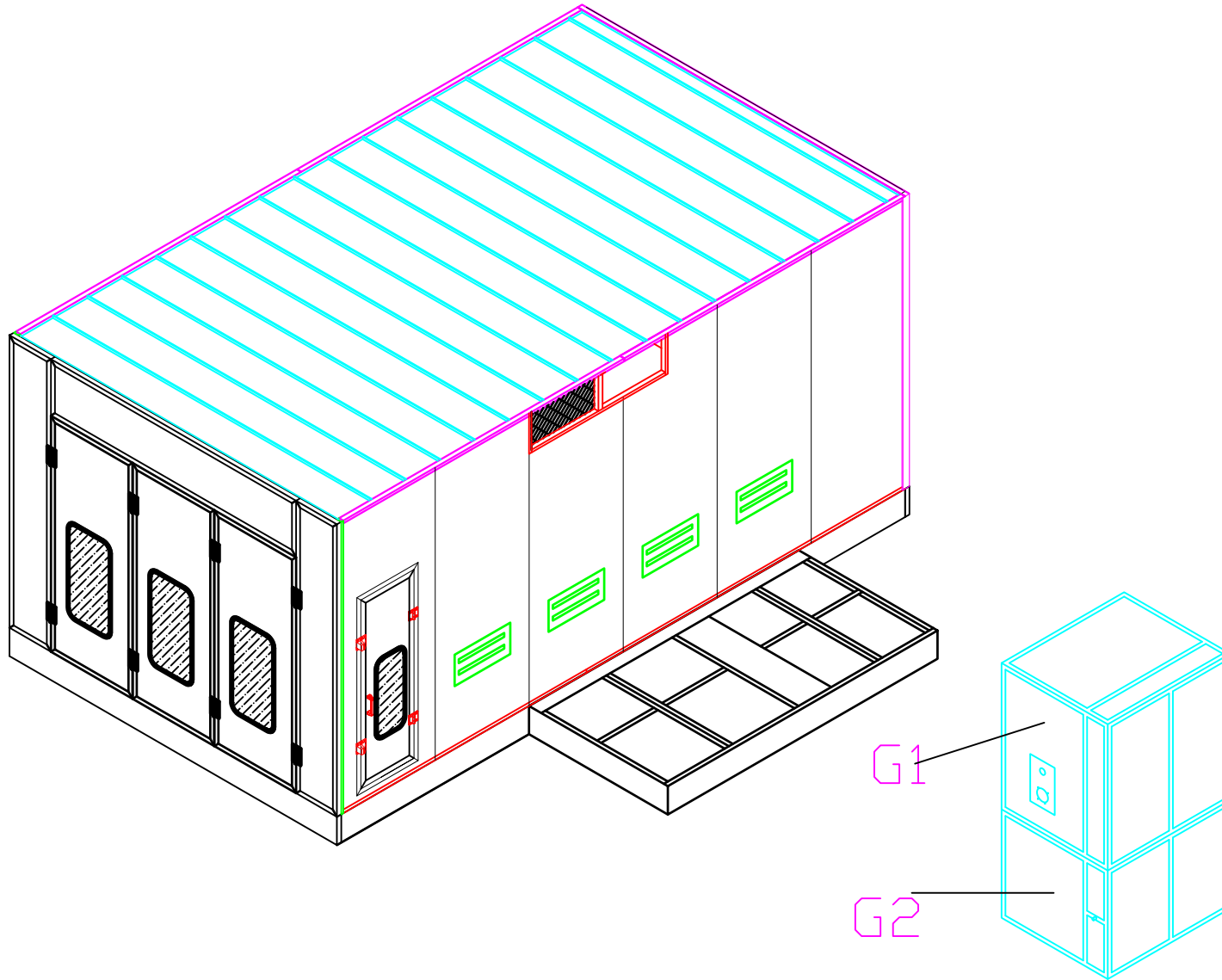

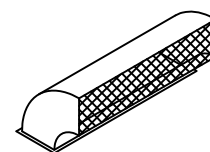
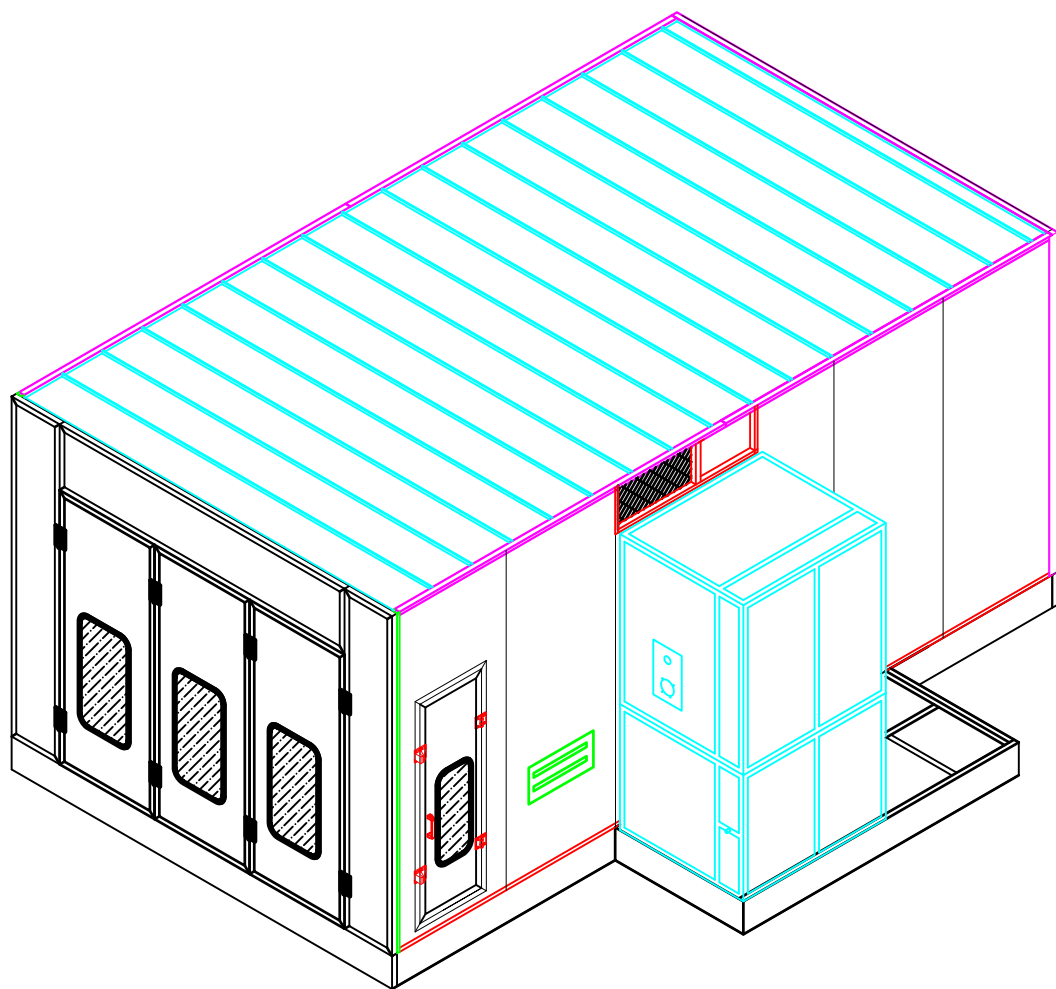

G5

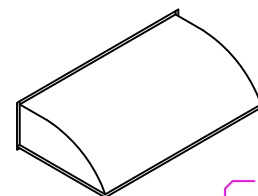

G6

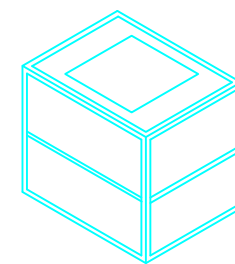
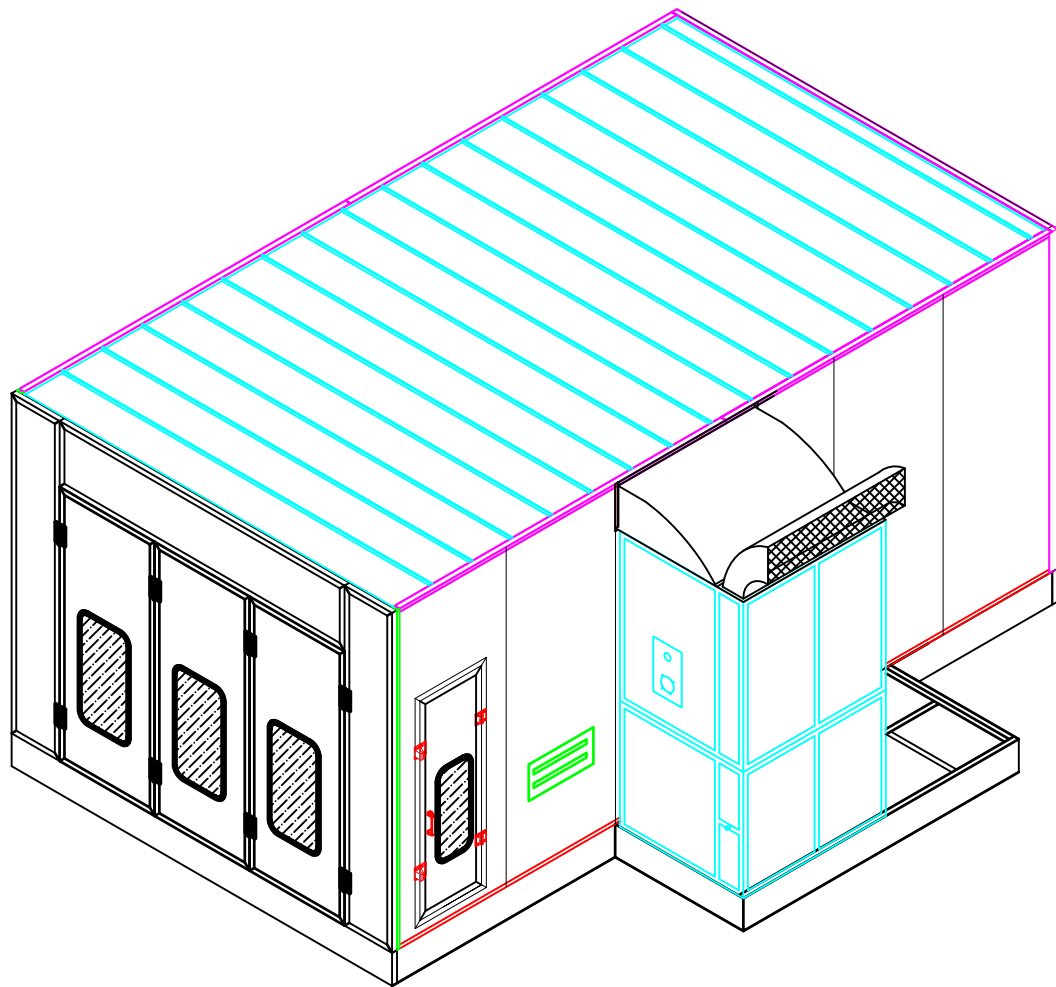

G4

037

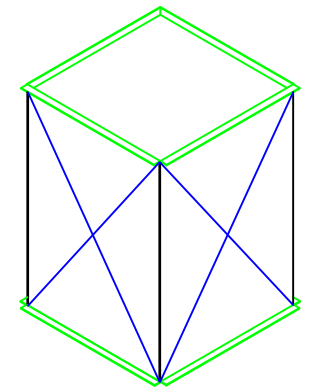
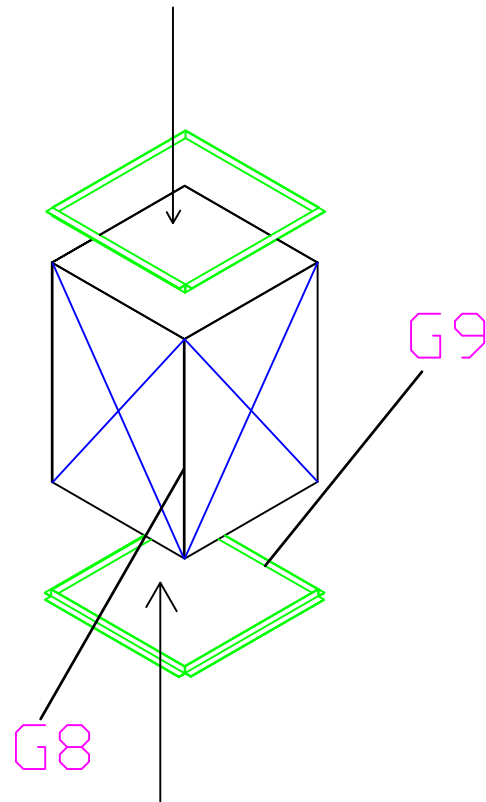
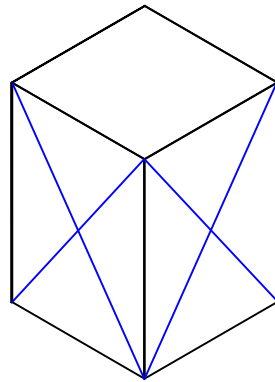
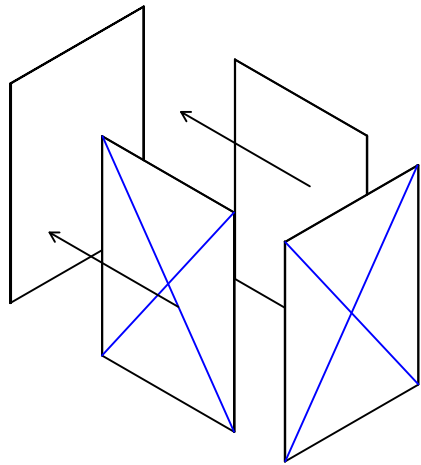

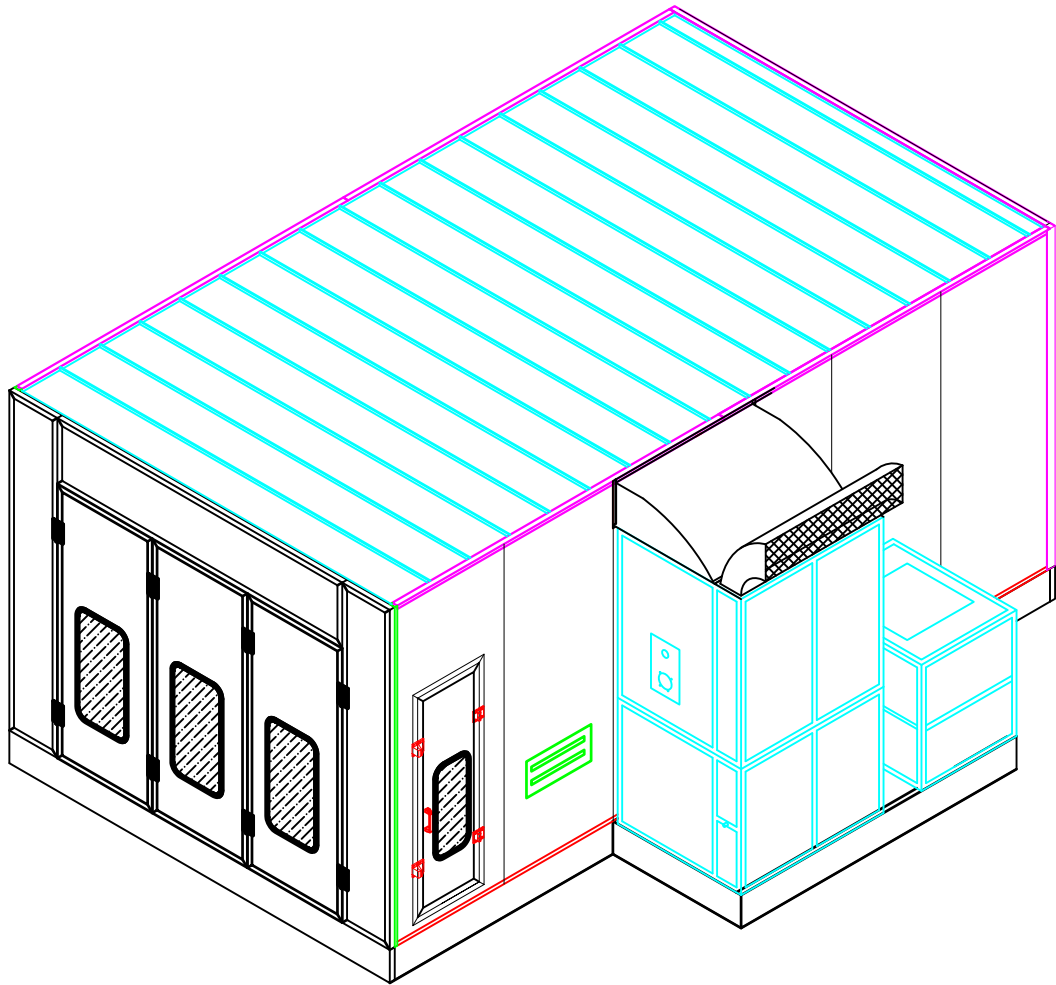

G11

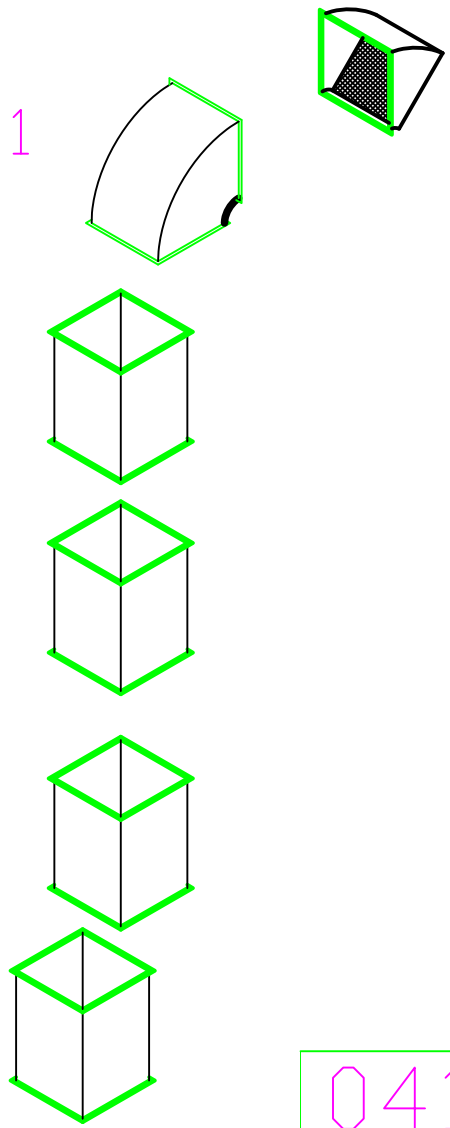

041

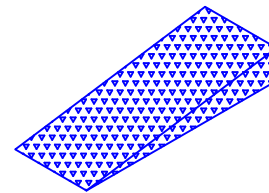
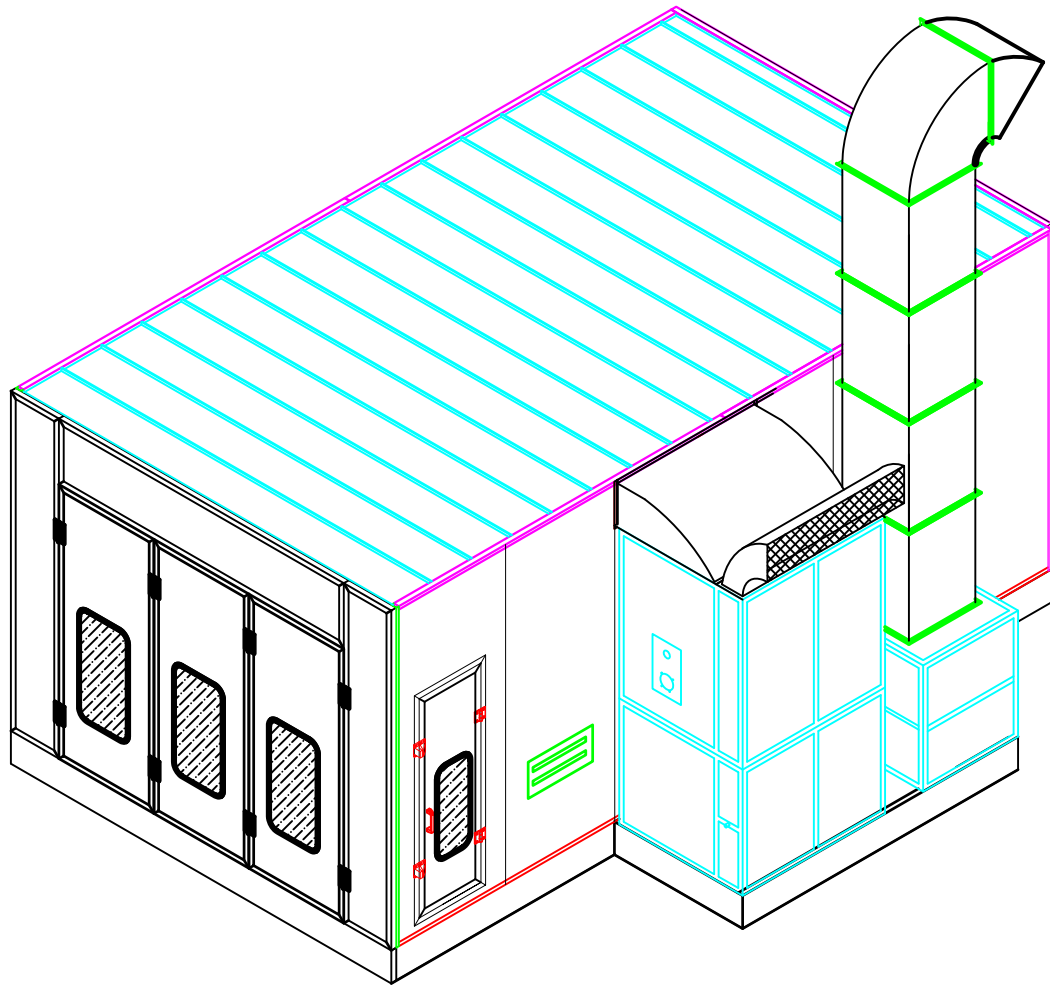

B7

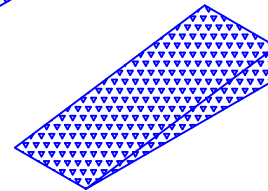

B8



